

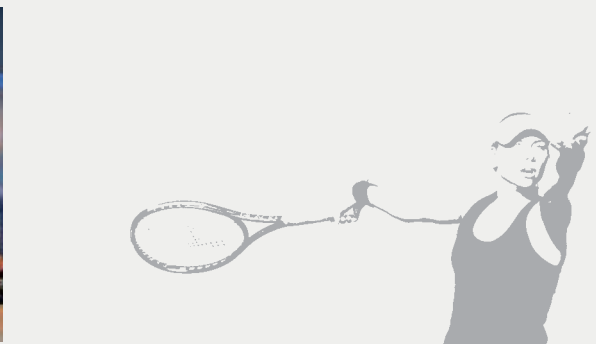

VIVISPORT



PASSIONE
PER LO SPORT
passion for sport

CATALOGO GENERALE
general catalogue



VIVISPORT



una storia di successi

a story of successes

COMPETENZA, CONSULENZA, CAPACITÀ TECNICA E COSTRUTTIVA:

QUESTE LE CARATTERISTICHE DISTINTIVE DI VIVISPORT, MA CE N'È UN'ALTRA CHE ACCOMUNA TUTTO IL NOSTRO TEAM, LA PASSIONE! PER NOI LO SPORT È INANZITUTTO PASSIONE, VOGLIA E CAPACITÀ DI OTTIMIZZARE PRODOTTI E SOLUZIONI TECNICHE PER SEMPLIFICARE E MIGLIORARE LE PRATICHE SPORTIVE. LA CONTINUA RICERCA DI MATERIALI E PROCESSI COSTRUTTIVI ED IL KNOW-HOW SPECIFICO, HANNO FATTO DI VIVISPORT, UN PARTNER TECNICO DI RIFERIMENTO PER L'ALLESTIMENTO DI MANIFESTAZIONI SPORTIVE INTERNAZIONALI. I PRODOTTI ILLUSTRATI IN QUESTO CATALOGO SONO SOLO UNA PICCOLA CATEGORIZZAZIONE DI ESEMPIO, MA LA RICERCA E L'OFFERTA DI PRODOTTI È IN COSTANTE EVOLUZIONE. NON ESITATE A CONTATTARCI PER QUALSIASI ESIGENZA, SAREMO LIETI DI RISPONDERE EFFICACEMENTE ALLE VOSTRE RICHIESTE.

COMPETENCE, CONSULTANCY, TECHNICAL AND CONSTRUCTIVE SKILLS:

THESE ARE THE DISTINCTIVE FEATURES OF VIVISPORT, BUT THERE IS ANOTHER FEATURE THAT OUR WHOLE TEAM SHARE: PASSION! ACCORDING TO US, SPORT MEANS FIRST OF ALL PASSION, AND DESIRE TO OPTIMIZE PRODUCTS AND TECHNICAL SOLUTIONS, IN ORDER TO SIMPLIFY AND IMPROVE SPORT PERFORMANCES. OUR CONTINUOUS RESEARCH OF MATERIALS AND CONSTRUCTIVE PROCESSES, AND OUR SPECIFIC KNOW-HOW, MADE VIVISPORT A REFERENCE PARTNER IN THE SET-UP OF INTERNATIONAL SPORT EVENTS. THE PRODUCTS THAT ARE ILLUSTRATED IN THIS CATALOGUE ARE JUST A LITTLE ILLUSTRATIVE CATEGORISATION, SINCE OUR RESEARCH AND OUR PRODUCT OFFER IS CONSTANTLY DEVELOPING. DO NOT HESITATE TO CONTACT US FOR ANY REQUIREMENT, WE WILL BE GLAD TO ANSWER EFFICIENTLY TO YOUR QUESTIONS.



VIVISPORT

ricerca, sviluppo ed esperienza

research, development and experience

CHI SCEGLIE VIVISPORT SA DI POTER CONTARE SU UN COLLABORATORE QUALIFICATO,
DISPONIBILE ED EFFICIENTE, ORGANIZZATO PER GARANTIRE LA TEMPESTIVA EVASIONE DEGLI ORDINI.
MA IL VALORE AGGIUNTO DI VIVISPORT È LA SUA FLESSIBILITÀ PRODUTTIVA; AD OGNI NUOVA RICHIESTA DEL CLIENTE
SEGUE UN'IMMEDIATA ATTIVAZIONE DELLO STUDIO TECNICO, PER SVILUPPARE LA "MIGLIORE SOLUZIONE",
E LA SUCCESSIVA REALIZZAZIONE NEI PROPRI REPARTI PRODUTTIVI.

PEOPLE WHO CHOOSE VIVISPORT KNOW THAT THEY CAN COUNT ON A QUALIFIED, HELPFUL AND EFFICIENT PARTNER,
WHICH IS ORGANIZED TO GUARANTEE THE PROMPT FULFILMENT OF EVERY ORDER. FURTHERMORE,
VIVISPORT'S ADDED VALUE LIES IN ITS PRODUCTIVE FLEXIBILITY; OUR TECHNICAL OFFICE STARTS TO WORK
IMMEDIATELY TO OUR CLIENTS' EVERY NEW REQUEST, IN ORDER TO ELABORATE THE BEST SOLUTION,
AND THEN TO FULFIL IT IN OUR PRODUCTION DEPARTMENTS.



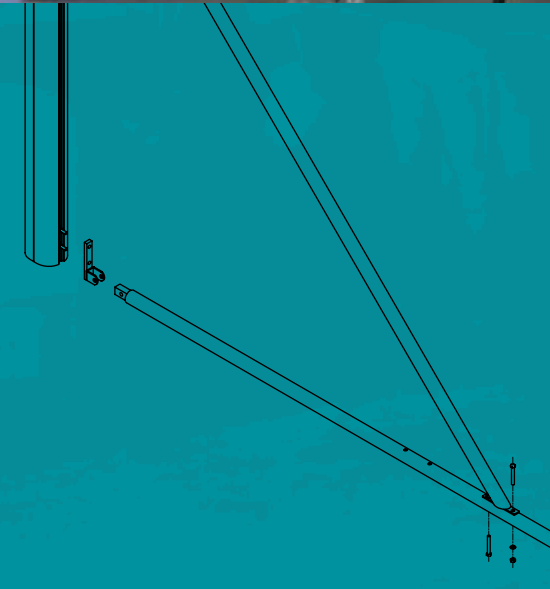
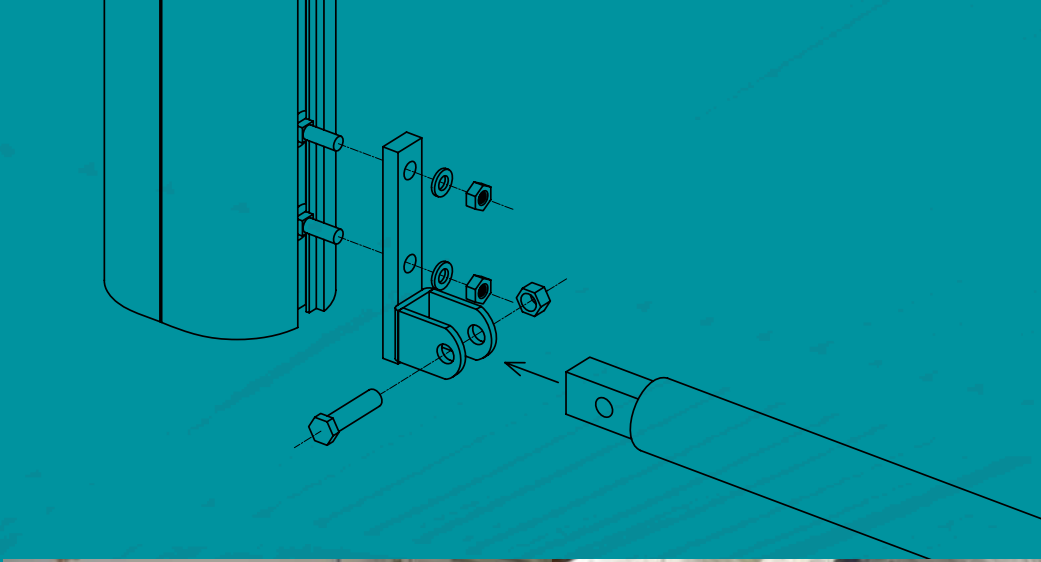

certificazioni

certifications

IN QUINDICI ANNI DI ATTIVITÀ VIVISPORT HA SVILUPPATO COMPETENZE TECNICHE, ORGANIZZATIVE E PRODUTTIVE TALI DA AVERLE PERMESSO DI RAGGIUNGERE ELEVATI STANDARD, SIA AZIENDALI CHE DI PRODOTTO.

LA QUALITÀ DEI NOSTRI PRODOTTI È GARANTITA DA IMPORTANTI ENTI CERTIFICATORI
VIVISPORT È IN GRADO DI STUDIARE, PROGETTARE E REALIZZARE ATTREZZATURE E IMPIANTI SPORTIVI, CONFORMI A DIRETTIVE NAZIONALI ED INTERNAZIONALI A SECONDA DELLE RICHIESTE SPECIFICHE DEL CLIENTE.

IN ITS FIFTEEN YEARS OF ACTIVITY, VIVISPORT HAS DEVELOPED TECHNICAL, ORGANIZATIONAL AND PRODUCTIVE SKILLS, THAT ALLOWED US TO REACH HIGH STANDARDS, BOTH WITH THE COMPANY AND WITH THE PRODUCTS. OUR PRODUCTS' QUALITY IS GUARANTEED BY IMPORTANT CERTIFICATION AUTHORITIES. VIVISPORT CAN STUDY, DESIGN AND FULFIL SPORTS FACILITIES AND EQUIPMENT, IN ACCORDANCE WITH NATIONAL AND INTERNATIONAL DIRECTIVES, AND WITH THE CLIENTS' SPECIFIC REQUESTS.







visione unica, molte soluzioni

a unique vision, many solutions

CON IL NUOVO CATALOGO VIVISPORT CONTINUA
LA SFIDA CON SE STESSA PER IL SUPERAMENTO DEGLI OBIETTIVI E RISULTATI RAGGIUNTI.
PER OGNI SPORT È STATA AMPLIATA E MIGLIORATA LA SEMPRE PIÙ VASTA GAMMA DI PRODOTTI,
DALLE OTTIME PRESTAZIONI A TUTTI I LIVELLI E USI.

*WITH THE NEW CATALOGUE VIVISPORT KEEPS ON
CHALLENGING ITSELF, IN ORDER TO EXCEED THE ACHIEVED GOALS AND RESULTS.
THE WIDER AND WIDER SET OF PRODUCTS FOR EACH SPORT, WHICH PERFORM EXCELLENTLY
ON EVERY LEVEL AND FOR EVERY USE, HAS BEEN EXTENDED AND IMPROVED.*



VIVISPORT

rapporti di prova

compliance certificates

I RAPPORTI DI PROVA CHE VENGONO EFFETTUATI, ATTESTANO LA CONFORMITÀ DEI PRODOTTI RISPETTO ALLE NORMATIVE INTERNAZIONALI DI SICUREZZA CONSENTENDO DI OTTENERE IMPORTANTI CERTIFICAZIONI.

THE REALIZED COMPLIANCE CERTIFICATES GUARANTEE THE CONFORMITY OF OUR PRODUCTS WITH INTERNATIONAL SAFETY REGULATIONS, AND ALLOW US TO OBTAIN IMPORTANT CERTIFICATIONS.

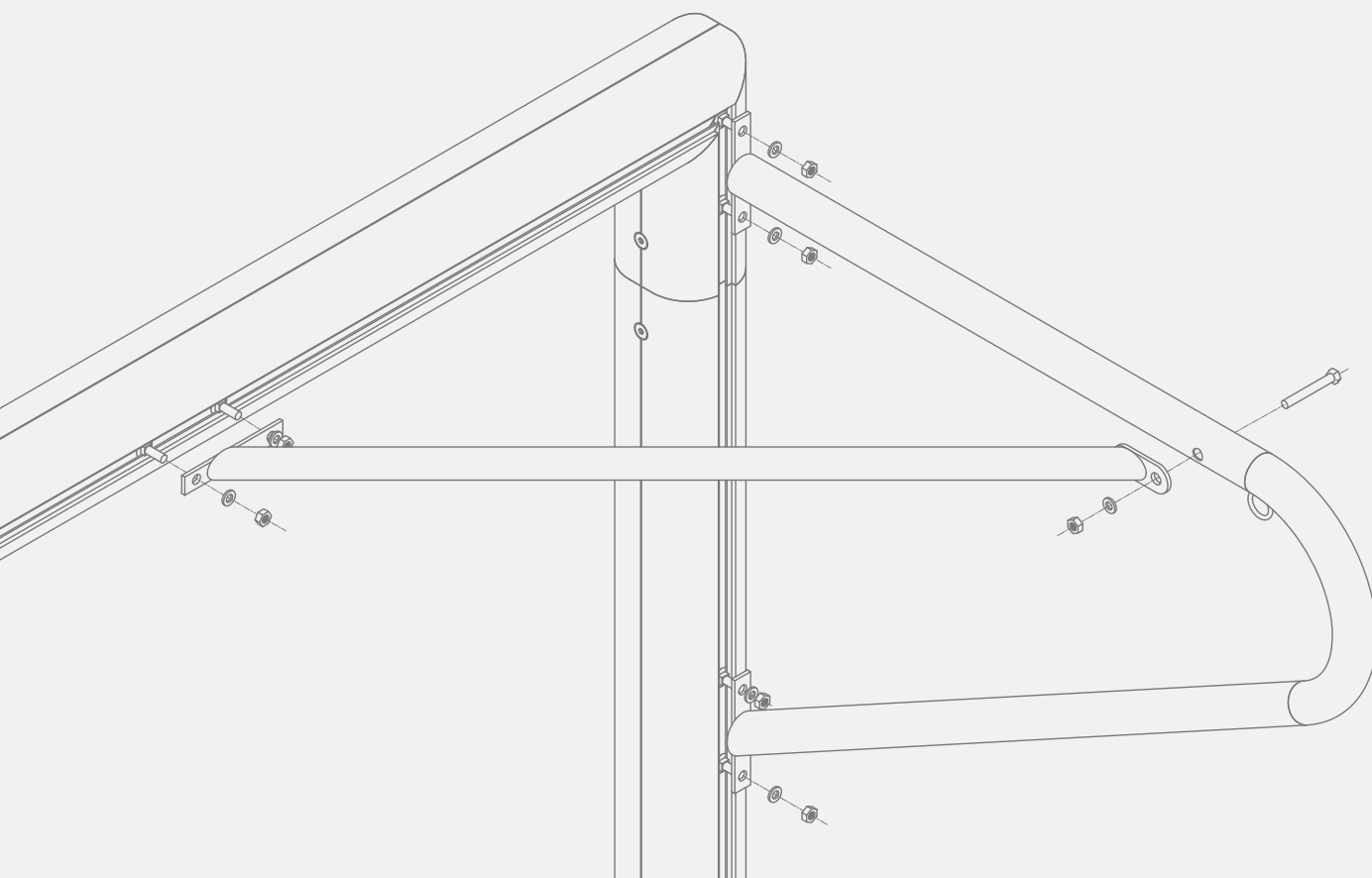

un team, una passione

one team, one passion

LA PASSIONE PER LO SPORT, E LA COSTANTE RICERCA DI SOLUZIONI INNOVATIVE HANNO PORTATO LA NOSTRA SQUADRA A CRESCERE E AFFERMARSI SUL MERCATO.

OUR PASSION FOR SPORT AND OUR CONSTANT RESEARCH OF INNOVATIVE SOLUTIONS LED OUR TEAM TO GROW AND TO ESTABLISH ITSELF ON THE MARKET.







indice

index

	CALCIO / <i>soccer</i>	17
	CALCETTO / <i>futsal</i>	57
	PALLAVOLO / <i>volleyball</i>	65
	BEACH VOLLEY	83
	BEACH SOCCER	91
	BEACH TENNIS	95
	PALLACANESTRO / <i>basket</i>	99
	TENNIS	121
	RUGBY	127
	PALLAMANO / <i>handball</i>	127
	BADMINTON / <i>badminton</i>	127
	TENNIS TAVOLO / <i>tennis table</i>	127
	ATLETICA / <i>athletics</i>	135
	GINNASTICA / <i>gymnastic</i>	145
	AEROBICA / <i>body building</i>	165
	PRIMA INFANZIA / <i>gym equipment for kids</i>	177
	TABELLONI ELETTRONICI / <i>scoreboards</i>	185
	TRIBUNE / <i>spectator seating systems</i>	193
	SPOGLIATOI - INFERMERIA / <i>dressing rooms - massage</i>	203
	PROTEZIONI DI SICUREZZA / <i>safety protections</i>	221
	ALTRI SPORT / <i>others sports</i>	225

CALCIO

soccer









art. 6340 Panchina struttura in alluminio con montanti frontali a sezione maggiorata 60x70 mm. antinfortunistica, copertura in policarbonato alveolato sp. mm. 4, telaio sedute in acciaio zincato a caldo.

Misure: altezza cm. 225, profondità a terra cm. 96, profondità totale cm. 138

Team shelter aluminium alloy construction, front struts construction mm. 60x70 cell-like polycarbonate panels thickness mm. 4. Dimensions: height cm. 225, ground depth cm. 96, total depth cm. 138

art. 6286 Protezione antiurto per panchina allenatori modello Strong e Strong Plus

Post pads for team shelters model "Strong" and "Strong Plus"



art. 6330 Panchina struttura in alluminio con montanti frontali a sezione maggiorata 60x70 mm. antinfortunistica, copertura in policarbonato trasparente sp. mm. 3, telaio sedute in acciaio zincato a caldo e scocche in polipropilene.

Misure: altezza cm. 225, profondità a terra cm. 96, profondità totale cm. 138

Team shelter aluminium alloy construction, front struts construction mm. 60x70 polycarbonate panels transparent thickness mm. 3, seats in polypropylene. Dimensions: height cm. 225, ground depth cm. 96, total depth cm. 138



art. 6212 Carrello in alluminio con ruote per il trasporto delle panchine staff tecnico modello Strong, Strong Plus e Standard. Realizzato su misura in base alla lunghezza della panchina

Aluminum cart with wheels for easy transport of the team shelter model Strong, Strong Plus and Standard



art. 5900 Porte calcio in alluminio mobili, gomiti saldati, autoportanti, a norme UNI EN 748

Freestanding soccer aluminium goals, welded corner joints, portable, in compliance with regulations UNI EN 748

art. 6108 Coppia reti calcio in nylon poliamide testurizzato, stab. U.V. mod. "esagonale extra" ø 6 mm

Soccer nets in texturized nylon polyamide, stab. U.V. mod. "hexagonal extra" ø 6 mm



art. 6036 Ruota gommata con staffa per trasporto porte calcio

Transport rubber wheel with bracket

art. 6044 Contenitori per zavorra da applicare su porte da calcio mobili NON a norma UNI o sulle porte calcetto mobili. Zavorra esclusa

Storage for ballast to apply to NO UNI freestanding soccer goals or freestanding futsal goals

art. 6041 Contenitori per zavorra da applicare su porte da calcio mobili a norma UNI ns. art. 5900

Storage for ballast to apply to item 5900



art. 5901 Porte calcio in alluminio mobili, gomiti saldati, autoportanti
Freestanding soccer aluminium goals, welded corner joints

art. 6107 Coppia reti calcio in treccia, 100% polietilene, stab. U.V. maglia 10x10 cm, lavorazione senza nodo - mod. "campionato"
Soccer nets in braid, 100% polyethylene, stab. U.V. mesh 10x10 cm, knotless, - mod. "championship"



art. 6047 Sacco di appesantimento per zavorrare le porte, in pvc elettrosaldato, riempibile di acqua o sabbia, con tappo di chiusura.
Bag for ballast to apply to goals, made in pvc, filled in water or sand



art. 6044 Contenitori per zavorra da applicare su porte da calcio mobili NON a norma UNI o sulle porte calcetto mobili. Zavorra esclusa
Storage for ballast to apply to NO UNI freestanding soccer goals or freestanding futsal goals



art. 6040 Protezione per ribaltina.
Tubolare spessore 20 mm per esterno. Moduli da 2 metri
Protective pad for net support 6038. Module of 2 mt Thickness 20 mm





art. 5905 Porte calcio in alluminio, reggiate a gomito, gomiti saldati, sez. 100x120 mm al paio complete di bussole, a norme UNI EN 748

Soccer aluminium goals, elbow net support, welded corner joints, section 100x120 mm per pair complete with sockets, in compliance with regulations UNI EN 748

art. 6100 Coppia reti calcio polietilene stab. U.V. ø 3 mm

Soccer nets in polyethylene stab. U.V. ø 3 mm per pair



art. 5907 Porte calcio in alluminio, reggiate a palo distanziato, gomiti sez. 100x120 mm al paio saldati, complete di bussole, a norme UNI EN 748

Soccer aluminium goals, free hanging net supports, welded section 100x120 mm per pair corner joints, complete with sockets, in compliance with regulations UNI EN 748

art. 6108 Coppia reti calcio in nylon poliamide testurizzato, stab. U.V. mod. "esagonale extra" ø 6 mm

Soccer nets in texturized nylon polyamide, stab. U.V. mod. "hexagonal extra" ø 6 mm



art. 5910 Porte calcio ridotte 6x2 in alluminio, con gomiti saldati, fisse, sez. 100x120 mm al paio

Soccer goals 6x2 in aluminium, welded corner joints, fixed, section 100x120 mm per pair complete with sockets

art. 6120 Coppia reti calcio ridotte per porte 6x2 in treccia polipropilene ø 3 mm stab. U.V., lavorazione senza nodo.

Small soccer nets for goals 6x2 in polypropylene braid ø 3 mm per pair stab. U.V., knotless



art. 6040 Protezione per ribaltina.
Tubolare spessore 20 mm
per esterno. Moduli da 2 metri
*Protective pad for net support
6038. Module of 2 mt Thickness
20 mm*



art. 590010 Gancio nylon verde per
applicazione rete su porte
calcio-calcetto alluminio
*Nylon hook to apply net on
aluminum soccer goals*



art. 5911 Porte calcio ridotte 6x2 in
alluminio, con gomiti saldati,
mobili sez. 100x120 mm al paio
*Freestanding soccer goals 6x2 in
aluminium, welded corner joints.
section 100x120 mm per pair*

art. 6120 Coppia reti calcio ridotte
per porte 6x2 in treccia
polipropilene \varnothing 3 mm stab.
U.V., lavorazione senza nodo.
*Small soccer nets for goals 6x2
in polypropylene braid \varnothing 3 mm
per pair stab. U.V., knotless*



art. 6038 Ribaltina per porte calcio
alluminio, in acciaio zincato
al paio
*Net support for soccer goals in
aluminium, in galvanised steel
per pair*



art. 6807 Vitone multiuso per
ancoraggio a terra cm 23
Goal anchor, multi purpose, cm 23



art. 6027 Porta calcio pulcini 4x2 in acciaio, mobili sez. ø 80 mm al paio

Freestanding junior soccer goals 4x2 in steel. section ø 80 mm

art. 6125 Coppia reti calcio ridotte per porte 4x2 in treccia polipropilene ø 3 mm stab. U.V., lavorazione senza nodo.

Small soccer nets for goals 4x2 in polypropylene braid ø 3 mm per pair stab. U.V., knotless



art. 6028 Porta calcio pulcini 4x2 in alluminio, mobili sez. ø 80 mm al paio

Freestanding junior soccer goals 4x2 in aluminium. section ø 80 mm

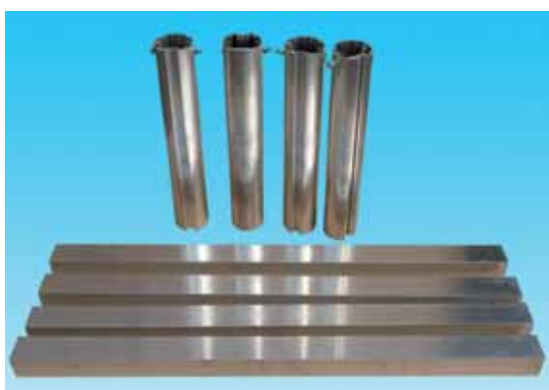

art. 6019

Kit di trasformazione da trasportabile a fissa per porte in alluminio sez. ø 80 mm al paio

Kit sockets to change freestanding soccer goal in fixed per pair



art. 6809

Picchetto per ancoraggio a terra porte calcio e calcetto

Goal anchor



Panchina allenatori personalizzate
Personalized coach benches



art. 6234 Panchina struttura in acciaio zincato a caldo, ricoperta in policarbonato alveolato, sp. mm 4, profilato mm 50x30, sedute a scocche in polipropilene (mod. Curvo) mt 6, 12 posti

Team shelter steel hot galvanised construction, cell-like polycarbonate panels thickness mm 4 construction mm 50x30, body work in polypropylene (curved model) mt 6, 12 seats



art. 6224 Panchina struttura in acciaio zincato a caldo, ricoperta in policarbonato trasparente, sp. 3, profilato mm 50x30, sedute a scocche in polipropilene (mod. Curvo) mt 6, 12 posti

Team shelter steel hot galvanised construction, transparent polycarbonate panels thickness mm 3 construction mm 50x30, body work in polypropylene (curved model) mt 6, 12 seats



art. 6254 Panchina struttura in profilato di lega d'alluminio rivestita in policarbonato trasparente sp. mm 3, profilato mm 50x30, sedute a scocche in polipropilene (mod.curvo) mt 6, 12 posti

Team shelter aluminium alloy construction, transparent polycarbonate panels thickness mm 3, construction mm 50x30, body work in polypropylene (curved model) mt 6, 12 seats



art. 6237 Panchina struttura in acciaio, misure e ricoperture varie

Team shelter steel structure, various sizes and shelters



art. 6286 Protezione antiurto per panchina allenatori modello **Strong e Strong Plus**

Post pads for team shelters model "Strong" and "Strong Plus"

art. 6214 Panchina struttura in alluminio con montanti frontali a sezione maggiorata 60x70 mm Antinfortunistica, copertura in policarbonato trasparente sp. mm 3, telaio sedute in acciaio zincato a caldo e scocche in polipropilene, mt 2, 4 posti

Team shelter aluminium alloy construction, front struts construction mm 60x70 polycarbonate panels transparent thickness mm 3, body work in polypropylene 1 ml, mt 2, 4 seats





art. 6291 Panchina struttura in alluminio trasportabile su ruote ricoperta in policarbonato alveolare, mt 3, 6 posti

Freestanding team shelter aluminium construction, portable on wheels, cell-like polycarbonate panels mt 3, 6 seats



art. 6293 Panchina struttura in alluminio trasportabile su ruote ricoperta in policarbonato alveolare, sedute su 2 file, 3 ml, 11 posti

Freestanding team shelter aluminium construction, portable on wheels, cell-like polycarbonate panels, seats on 2 rows, ml 3, 11 seats





Panchina allenatori modulare con struttura in alluminio 40x20 mm, copertura in policarbonato alveolare sp. 4 mm, sedute impilabili con struttura in acciaio zincato e doghe in alluminio anodizzato. La copertura e la seduta è composta da moduli da 1 metro.

Modular team shelter in aluminium construction 40x20 mm, cell-like polycarbonate panels thickness 4 mm, stackable seats made with galvanized steel and beams in anodized aluminium. 1 meter modular.

art. 6240 Paio fianchi

Pair of sides

art. 6241 Copertura e sedute modulo da 1 metro

1 meter cover and seat



art. 6330 Panchina struttura in alluminio con montanti frontali a sezione maggiorata 60x70 mm antinfortunistica, copertura in policarbonato trasparente sp. mm 3, telaio sedute in acciaio zincato a caldo e scocche in polipropilene.

Team shelter aluminium alloy construction, front struts construction mm 60x70 polycarbonate panels transparent thickness mm 3, body work in polypropylene

art. 6212 Carrello in alluminio con ruote per il trasporto delle panchine staff tecnico modello Strong, Strong Plus e Standard.

*Realizzato su misura in base alla lunghezza della panchina
Aluminum cart with wheels for easy transport of the team shelter model Strong, Strong Plus and Standard.*



art. 6286 Protezione antiurto per panchina allenatori modello Strong e Strong Plus

Post pads for team shelters model "Strong" and "Strong Plus"

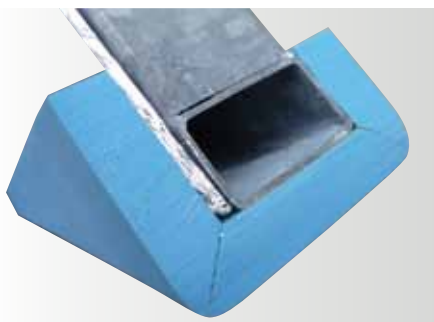

art. 6285 Protezione antiurto per panchina allenatori già applicata

Post pads for team shelters



art. 6289 Rinforzo antistrappo in alluminio per copertura panchine staff tecnico (sono necessari 2 pz. ogni modulo)

Reinforcement no-rip in aluminium for team shelter cover 2 pieces per module



art. 6286 Protezione antiurto per panchina allenatori modello Strong e Strong Plus

Post pads for team shelters model "Strong" and "Strong Plus"



art. 62203 Scocca di ricambio panchine allenatori

Seat model for team shelter



art. 6490 Tunnel estensibile e scorrevole su ruote, struttura in alluminio, rivestimento in PVC ignifugo

Soccer tunnel extensible pantograf, aluminium structure



art. 5907 Porte calcio in alluminio, reggirete a palo distanziato, gomiti saldati, complete di bussole, CERTIFICATE UNI EN 748

Soccer aluminium goals, free hanging net supports, welded corner joints, complete with sockets, in compliance with regulations UNI EN 748

art. 6043 Protezione per n° 1 palo reggirete distanziato per porte calcio art. 5907

Protective pad for n° 1 net support for item 5907



art. 6042 Protezione per la ribaltina di n° 1 porta calcio regolamentare, in gomma e con fodera con chiusura a velcro

Protective pad for n° 1 net support 6038



art. 6431 Carrello segnacampo a vernice ecologica a motore, struttura in acciaio tropicalizzato, con 4 ruote

Motor spray line marker, made in steel tropicalized, with 4 wheels



art. 6432 Carrello segnacampo a vernice ecologica, pompa manuale, struttura in acciaio tropicalizzato, con 4 ruote
Spray line marker, with manual pump and 4 wheels



art. 6495 Vernice ecologica per carrello segnacampo conf. 18 Kg
Biodegradable fluid for line marker, pack 18 Kg



art. 6026 Plifix per segnalazione campi
Plifix for line marking



art. 6492 Vernice ecologica concentrata per manti erbosi. Conf. da 3 litri con una confezione di riesce a tracciare un campo da calcio
Concentrated paint for grass surfaces. Box of 3 liters. With a box you can draw a football field



art. 6439 Macchina tracciatrice a spruzzo automatica
Spray line automatic marker



art. 6422 Carrello segnacampo con ruota indicatrice a gesso con ruote gommate
Galvanized line marker for dry materials

art. 6478 Spazzola di ricambio per carrello segnacampo a gesso in mopen
Spare part nylon brush for chalk line marker



art. 6008 Porte 170x105 cm., in alluminio, mobili, reti incluse

Training soccer goals in aluminium, size 170x105 cm., nets included



art. 6007 Porte 150x100 cm. tutta in ALLUMINIO sezione 40 mm. complete di reti

Pair of minigoal 150x100 cm., made in aluminium, nets included



art. 6030 Porte minicalcio in acciaio, 150x100 cm, completa di rete

Court soccer minigoals in steel 150x100 cm, net included



art. 6032 Porte per allenamento in plastica antiurto 150x110x80 cm, con reti al paio

Court soccer minigoals in shockproof 150x110x80 cm, net included



art. 1752 Mini trampolino altezza fissa

Mini springboard, fixed height



art. 1709 Trampolino elastico fisso completo di imbottitura
Fixed elastic springboard complete with padding



art. 6108 Coppia reti calcio in nylon poliamide testurizzato, stab. U.V. ø 6 mm mod. "esagonale extra"
Soccer nets in texturized nylon polyamide, stab. U.V. mod. "hexagonal extra"



art. 6486 Sagoma snodata per barriera e slalom regolabile in altezza
Flex dummy height adjustable

art. 6487 Carrello adatto per una barriera art. 6486 e 6476
Trolley for 1 dummy 6476 and 6486

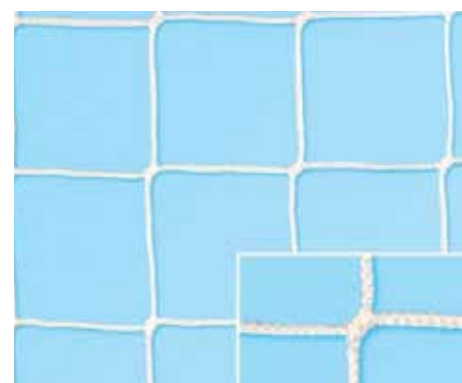

art. 6107 Coppia reti calcio in treccia, 100% polietilene, stab. U.V. ø 6 mm maglia 10x10 cm, lavorazione senza nodo - mod. "campionato"
Soccer nets in braid, 100% in polyethylene, stab. U.V. mesh 10x10 cm, knotless mod. "championship"



art. 6105 Coppia reti calcio in treccia, 100% polietilene, stab. U.V. ø 4 mm maglia 12x12 cm, lavorazione con nodo - mod. "world cup"
Soccer nets in braid, 100% in polyethylene, stab. U.V. ø 4 mm per pair mesh 12x12 cm, knot manufacturing - mod. "world cup"



art. 6476 Sagoma snodata per barriera e slalom
Flex Dummies made from ABS reinforced



art. 6420 Carrello porta sagome per barriera nr. 5 pezzi
Dummies trolley for set of 5



art. 6475 Sagoma fissa per barriera e slalom
Dummies made from PP boards, height adjustable



art. 6488 Sagoma art. 6475 completa di base zavorrata
Dummy with trolley light model



art. 6465 Sagoma gonfiabile con piedistallo riempibile art. 185 cm
Inflatable dummy 185 height with weighted base



art. 6479 Sagome brevettate altezza cm180 peso Kg 3,5
Patented dummies



art. 6423 Carrello porta sagome art. 6479/6480 in acciaio zincato
Dummies trolley for set of 5.pcs., wheels with bladder. For item 6479-6480



art. 6480 Barriera filtrante modello "Reflex" (carrello art. 6423 escluso)
Filtering barrier model "Reflex". (Trolley it. 6423 not included)



art. 6047 Sacco di appesantimento per zavorrare le porte, in pvc elettrosaldato, riempibile di acqua o sabbia, con tappo di chiusura.
Bag for ballast to apply to goals, made in pvc, filled in water or sand



art. 6318 Pallone cuoio per forca
The tethered soccer ball



art. 6452 Forca per gioco testa-braccio mt 3
Header practice stand with two positions

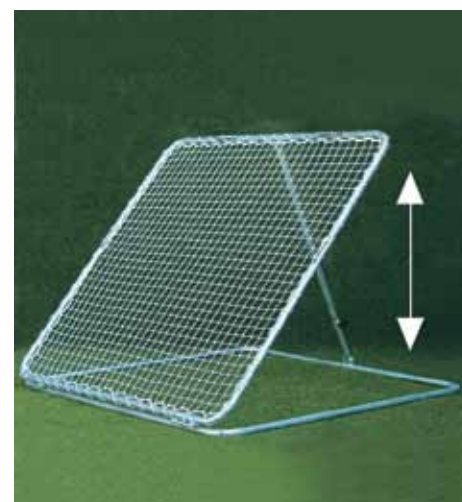

art. 6451 Telaio con rete ad inclinazione variabile per allenamento cm 140x140
Iron frame with net, adjustable inclination for goal-keepers and players



art. 6481 Slitta per traino a carico variabile, completa di cintura in pelle, corda e moschettoni. Pesi esclusi.
Sledge (weights not included) to improve players' acceleration, including leather belt, rope and chain



art. 6484 Simulatore di muro in vetroresina a 3 facce, spostabile su ruote cm 130x110 ogni pannello
3 Faces fiberglass players' rebounder on wheels every face dimensions cm 130x110

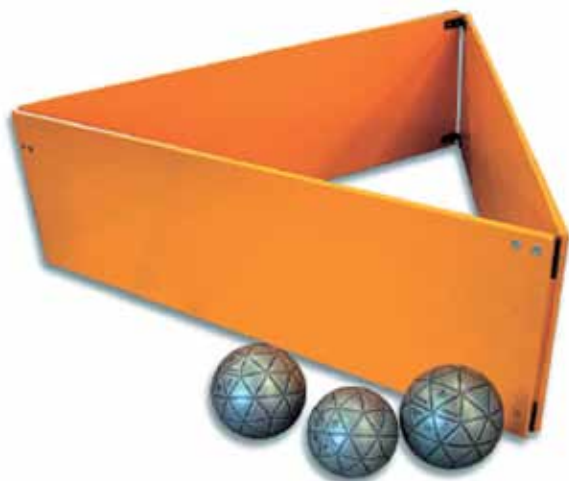

art. 6485 Simulatore di muro in legno marino multistrato a 3 facce, cm 150x50 ogni pannello
3 Faces trated wood for outdoor, every face dimensions cm 150x50



art. 6483 Simulatore di muro per allenamento portieri in vetroresina su ruote, cm 130x200 altezza
Fiberglass goal-keeper rebounder on wheels



art. 2330 Elastico con imbragatura Stroops per corsa trattenuta, resistenza 35 kg. composto da un elastico lungo 305 cm, un'imbragatura pettorale imbottita ed una fascia ad anello per l'ancoraggio.
Harnes with elastic 3 meters long fot trantion, strength 35 kg.

art. 2331 Elastico con imbragatura Stroops per corsa trattenuta, resistenza 48 kg. composto da un elastico lungo 305 cm, un'imbragatura pettorale imbottita ed una fascia ad anello per l'ancoraggio.

Harnes with elastic 3 meters long fot trantion, strength 48 kg.

art. 2332 Elastico con imbragatura Stroops per corsa trattenuta, resistenza 68 kg. composto da un elastico lungo 305 cm, un'imbragatura pettorale imbottita ed una fascia ad anello per l'ancoraggio.

Harnes with elastic 3 meters long fot trantion, strength 68 kg.



art. 6404 Impianto calcio per perfezionare il palleggio aereo
Traning play ball, net included



art. 6516 Cubo propriocettivo misura 50x50x50 cm., in legno con fondo e piano superiore dotato di antiscivolo, con impugnature per il trasporto
Proprioceptive cube, size 50x50x50 cm., made in wood, antislip bottom and top sides



art. 5083 Pedana salto con cintura ed elastico
Jump springboard with belt and elastic rope



art. 5084 Barra con elastici a resistenza regolabile
Bar with elastic adjustable resistance

art. 9178 Panca Jump regolabile in altezza per pliometria
Jump bench adjustable in height for plyometrics



art. 9312 Maxipallone psicomotorio ø 65 cm
Big ball for psychomotor ø 65 cm



art. 2042 Tavoletta in legno unita ad una palla ellittica gonfiabile
Wood board with pumping elliptical sphere



art. 2040 Piano galleggiante resistenza variabile
Floating board, adjustable resistance



Associazione Italiana
Preparatori Atletici Calcio



art. 2041 Semisfera equilibrio a rigidità ed elasticità variabile

Balance half sphere, varying rigidity and elasticity, with elastic band



art. 2201 Cerchio per pilates

Pilates circle

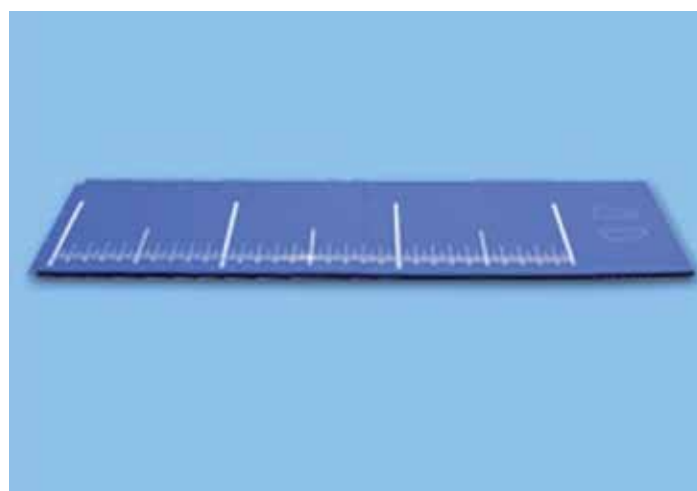

art. 5438 Mat-test, lunghezza cm 370, larghezza cm 100

Mat-test lenght cm 370 width cm 100



art. 9323 Disco propriocettivo in gomma gonfiabile. ø 40 cm ideale per il calcio

Disk proprioceptor. ø 40 cm - Ideal for the soccer training



art. 2039 Cubo con maniglia a peso variabile da 1 Kg a 5 Kg riempibile con acqua o sabbia. Ideale per esercizi con le gambe.

Cube with handle, refillable with water or sand. Weight from 1 Kg to 5 Kg



art. 2038 Palla con maniglia a peso variabile da 0,9 Kg a 3 Kg riempibile con acqua o sabbia

Ball with handle, refillable with water or sand. Weight from 0,9 Kg to 3 Kg



art. 9324 Kit per esercizi specifici sulla stabilità, propriocettività e forza. IDEALE PER IL CALCIO

- n° 1 maxipallone diam. 42 cm nero;
- n° 1 fitball roller lungo 75 cm largo 24 cm silver
- n° 1 fitball roller lungo 78 cm largo 17 cm silver
- n° 1 imbragatura per maxipallone ø 42 cm
- n° 1 imbragatura per fitball roller lungo 75x24 cm
- n° 1 rimuovi tappo
- n° 1 dvd con esercizi

Kit for specific exercises on the stability, proprioception and strength IDEAL FOR THE SOCCER
 n° 1 psychomotor ball diam. 42 cm black;
 n° 1 fitball roller, length 75 cm, width 24 cm silver
 n° 1 fitball roller length 78 cm, width 17 cm silver
 n° 1 harness for psychomotor ball ø 42 cm
 n° 1 harness for fitball roller length 75x24 cm
 n° 1 caps remover
 n° 1 dvd with exercises

art. 9325 Kit per esercizi sulla propriocettività degli arti superiori IDEALE PER LA PREPARAZIONE DEI PORTIERI

- n° 2 palle peso 200 gr. ø 22 cm
- n° 2 palle peso 300 gr. ø 22 cm
- n° 2 palle peso 400 gr. ø 22 cm
- n° 2 palle peso 600 gr. ø 22 cm
- n° 2 palle peso 800 gr. ø 22 cm
- n° 2 palle peso 1000 gr. ø 22 cm
- n° 1 pompa
- n° 1 dvd con esercizi
- n° 1 libretto con guida agli esercizi ed istruzioni

Kit exercise on proprioception of the upper limbs IDEAL FOR THE SOCCER GOALKEEPER TRAINING
 n° 2 balls weight 200 gr., ø 22 cm
 n° 2 balls weight 300 gr., ø 22 cm
 n° 2 balls weight 400 gr., ø 22 cm
 n° 2 balls weight 600 gr., ø 22 cm
 n° 2 balls weight 800 gr., ø 22 cm
 n° 2 balls weight 1000 gr., ø 22 cm
 n° 1 pump
 n° 1 dvd with exercises
 n° 1 booklet with exercises and instructions





art. 9429 Cono forato alt. cm 50 con 16 fori
Drilled cone, height 50 cm with 16 holes



art. 9418 Cono calpestabile alto 13 cm. in pvc morbido, senza fori
Drilled cone, walkable 13 cm high. soft pvc, without holes



art. 9424 Cono forato alt. cm 30 con 8 fori
Drilled cone, height 30 cm with 8 holes



art. 2052 Giubbotto zavorrato per allenamento pesi ricaricabili 10 Kg
Ballasted jacket for training reloaded weights 10 Kg



art. 6442 Delimitatore multiuso alt. cm 15, 12 fori laterali
Marker with 12 holes



art. 6440 Kit 48 delimitatori alt. cm 5 con rimessaggi
Kit 48 markers 5 cm, with holder



art. 3023 Ostacolo regolabile in acciaio verniciato
alt. cm 30-40-50
Adjustable hurdle in painted steel, height cm 30-40-50

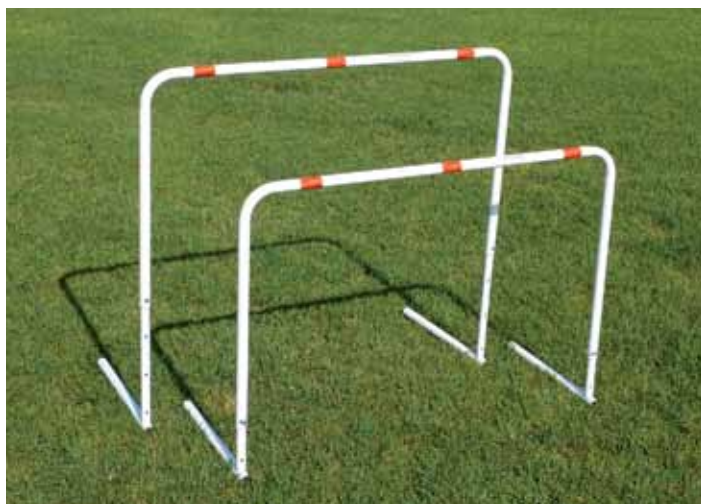

art. 3024 Ostacolo regolabile in acciaio verniciato
alt. cm 60-70-80-90
Adjustable hurdle in painted steel, height cm 60-70-80-90



art. 3016 Ostacolo in alluminio, regolabile da 60 a 100 cm,
smontabile
Aluminium hurdle, adjustable cm 60 / 100



art. 3047 Ostacolo in pvc richiudibile con meccanismo a molla.
Altezza 20-30-40-50-60 cm.
Hurdle in pvc, folding system, height cm. 20-30-40-50-60

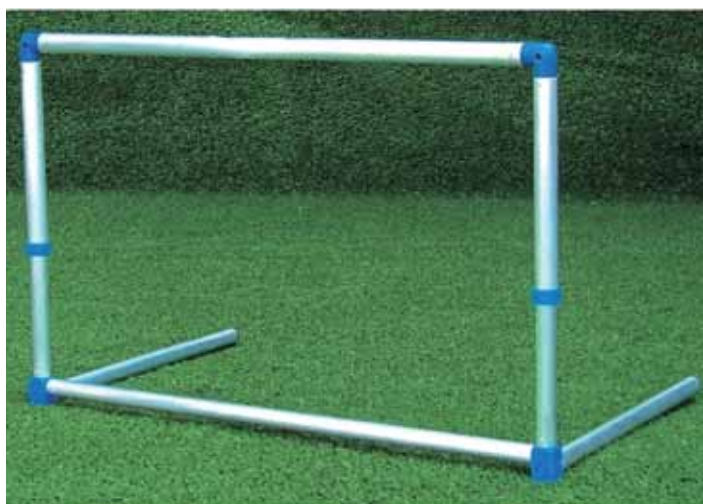

art. 3015 Ostacolo in alluminio, regolabile da 40 a 60 cm,
smontabile
Aluminium hurdle, adjustable cm 40 / 60

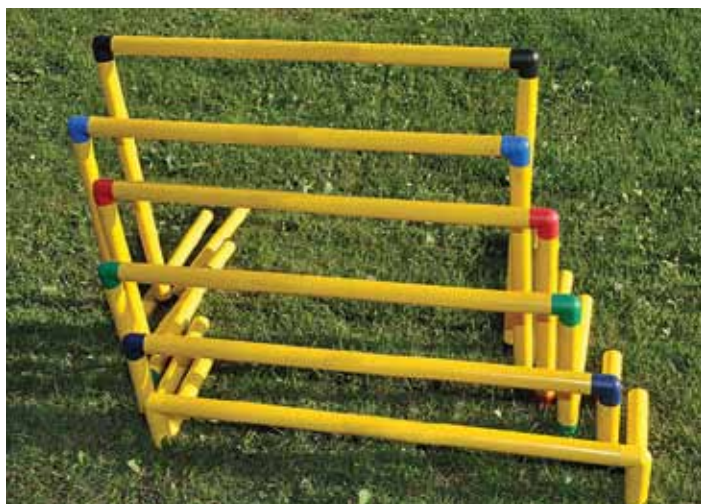

art. 3046 Ostacolo over in pvc altezza cm. 12-20-30-40-50-60
Hurdle in pvc, height cm. 12-20-30-40-50-60



art. 6456 Ostacolo graduabile per allenamento con base, alt. 140 cm

Training adjustable hurdle with base height cm 140

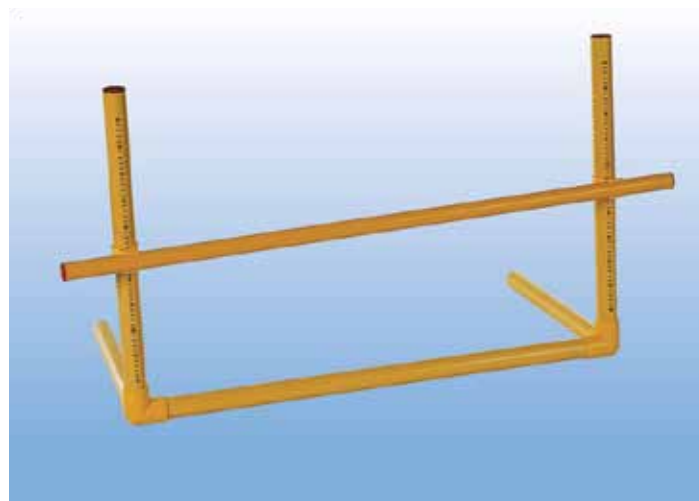

art. 3018 Ostacolo regolabile da cm 5 a cm 100 con traversa

Hurdle adjustable from cm 5 to cm 100 with one cross bar



art. 3020 Ostacolino in acciaio altezza fissa
cm 12-14-16-18-20-22-24-26-28-30

*Steel hurdles, fixed eight
cm 12-14-16-18-20-22-24-26-28-30*



art. 3021 Ostacolino in alluminio/asticella in pvc altezza fissa
cm 12-14-16-18-20-22-24-26-28-30

*Steel and PVC hurdles, fixed eight
cm 12-14-16-18-20-22-24-26-28-30*



art. 3019 Ostacolo over, flessibile anti rottura, in tubo pieno di pvc, piegato a caldo altezza fissa.
Misure a scelta: cm 12-14-16-18-20-30-40-50-60

Mini over in pvc fixed height





art. 6502 Porta per tiro precisione e slalom

Goal for precision shot and slalom



art. 6503 Scala per allenamento calcio a 7 rettangoli da 70x50 cm Specifico per uso nell'erba

Soccer training ladder, 7 rectanglers 70x50 cm Suitable for grass complete with bag



art. 6501 Scala per allenamento calcio a 36 quadri da 50x50 cm completa di borsa

Soccer training ladder, coordination system, 36 squares, 50x50 cm, complete with bag



art. 6498 Scala per coordinazione di frequenza da 7,70 mt completa di 4 picchetti e sacca

Coordination ladder, 7,70 mt, complete with 4 ground anchors and bag

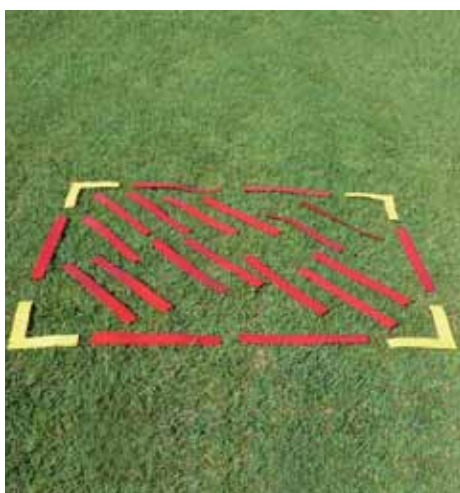

art. 6441 Delimitatore per area gioco set

Limit marker for playing area set



art. 6504 Scala per allenamento calcio, 10 pioli piatti, lunghezza 4 metri, unibile ad altre scale per aumentare la lunghezza

Speed ladder, 4 mt. long, modular



art. 6505 Casacca in poliestere colore arancio

Jacket color orange

art. 6506 Casacca in poliestere colore giallo

Jacket color yellow

art. 6507 Casacca in poliestere colore blu

Jacket color blue

art. 6508 Casacca in poliestere colore rosso

Jacket color red

art. 6509 Casacca in poliestere colore verde

Jacket color green



art. 6403 Set 4 pali angolo snodato con bussole, bandierine, clips
Set of 4 flexible plastic corner poles, with sockets, flags, clips



art. 6401 Set 4 pali angolo fisso con bussole, bandierine, clips
Set of 4 fixed plastic corner poles with sockets, flags, clips



art. 6457 Paletto slalom fisso puntale acciaio, sez. 30 mm alt. cm 160
Fixed slalom pole, with steel tip, section 30 mm height cm 160



art. 6461 Paletto slalom con base per allenamenti sez. mm 30
Slalom pole with base for training, section mm 30



art. 1377 Stuoia arrotolabile liscia in PE 180x50x0,7 cm
Rolling up mat smooth in PE 180x50x0,7 cm



art. 6454 Lavagna tattica gioco calcio con set scrittura
Football game tactic backboard with writing set

art. 6460 Compressore elettrico portatile 220 volt
Portable electric compressor 220 volt

art. 6496 Pompa a staffa con manometro
Braket pump



art. 6510 Macchina lavascarpe
Machine wash shoes



art. 6494 Pompa a mano per palloni, a doppia azione, con ago compreso
Hand pump, double action, for balls, with needle included

art. 6464 Manometro per controllo e regolazione della pressione dei palloni
Manometer to control ball pressure



art. 6405 Set 2 aste guardialinee complete di bandierine gialle in busta
Set of 2 linesman flags with plastic handle

art. 6407 Drappo a scacchi per aste guardialinee dim. cm 40x40
Spare nylon flag for linesman flag cm 40x40

art. 6406 Drappo fluo per aste calcio d'angolo dim. cm 60x40
Spare nylon flag for corner pole cm 60x40



art. 6470 Rete in polietilene verde \varnothing 3 mm
maglia cm 10x10. Certificata
UNI-EN 1263-1 al mq
*Net in polyethylene green \varnothing mm 3
mesh cm 10x10 - UNI EN 1263-1*



art. 6474 Cavo in acciaio zincato \varnothing 5 mm
per rete
Galvanized steel cable for net



art. 6409 Borraccia (nr. 6 pezzi da lt. 1)
completa di cestello
*Water bottle (no. 6 pcs. 1 litre)
complete with basket*



art. 6415 Segnalatore cambio giocatori manuale bifacciale
fluo giallo/arancio
*Scoreboard manual players visible two faces, with
fluorescent segment*



art. 6408 Blocco numeri sostituzione giocatori
con impugnatura 1/25
Players substitute indicators with handgrip 1/25

art. 6410 Blocco numeri sostituzione giocatori
con impugnatura 1/30 in
Players substitute indicators with handgrip 1/30 in

art. 6411 Blocco numeri sostituzione giocatori
con impugnatura 1/30 out
Players substitute indicators with handgrip 1/30 out



art. 6443 Tabellone elettronico per cambio giocatori, 4 cifre,
monofacciale cm 55,5x36x4
*Electronic players substitute indicators with four digits,
single sided cm 55x5x36x4*

art. 6444 Tabellone elettronico per cambio giocatori, 4 cifre,
bifacciale cm 55,5x36x4
*Electronic players substitute indicators with four digits,
double sided cm 55x5x36x4*

COLONNA VERTEBRALE

Miglioramento e stabilità mediante utilizzo del maxipallone. Come utilizzare il maxipallone nella prevenzione e stabilità della colonna vertebrale in situazione domestica.

prof. Paolo Artico



SPINAL COLUMN

Improvement and stability through the use of a gym ball. How to use a gym ball for the protection and stability of your spinal column in a domestic situation.

prof. Paolo Artico

FORZA E STABILITÀ

Miglioramento della forza e della stabilità mediante utilizzo del maxipallone. Forza, equilibrio e prevenzione mediante l'utilizzo del maxipallone per una maggiore potenza ed elasticità degli arti inferiori.

prof. Paolo Artico

STRENGTH AND STABILITY

Improve strength and stability through the use of a gym ball. Strength, balance and protection through the use of a gym ball for greater power and elasticity of the lower limbs.

prof. Paolo Artico

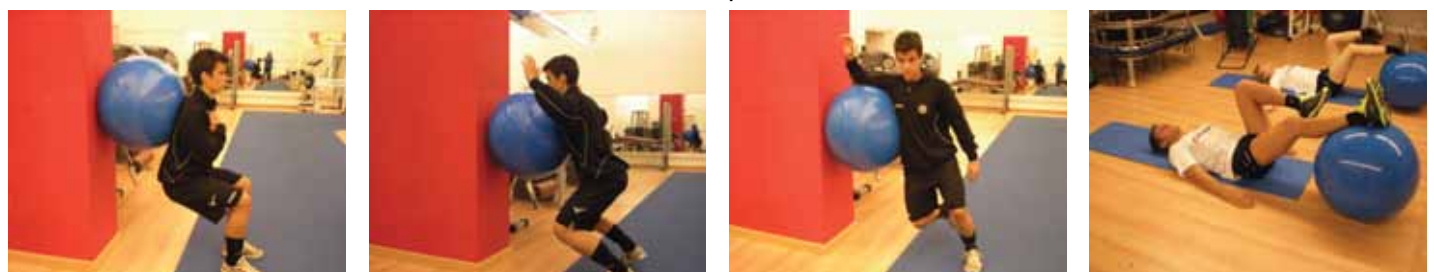



Associazione Italiana
Preparatori Atletici Calcio

prof. Andrea Bellini





Modulo tribuna da 2,5 metri a 3 file in acciaio, ribaltabile, con n° 15 seggiolini

Compact stand use 2,5 mt with 3 steps, in steel, foldable, with 15 seats

art. 8570 Modello fisso in acciaio

Fix in steel

art. 8575 Kit ruote di trasformazione da fissa a trasportabile per moduli tribuna art. 8570 - 8571

Kit of wheels to transform from fix to mobile for the compact stands item 8570 - 8571



CALCETTO

futsal



VIVISPORT



art. 6812 Sistema di fissaggio rapido a terra con uncino per porte calcetto o pallamano. Il sistema comprende n° 1 staffa con un uncino completo di pomello di regolazione

*Quick fixing system on the ground with hook for futsal and handball goals
Socket not included*

art. 6813 Bussola per sistema di fissaggio a terra con uncino art. 6812

Socket for item 6812



art. 6800 Porte per calcetto in acciaio, verniciate a fuoco, mobili, compl. smontabili al paio
Steel futsal goals 300x200 cm, freestanding, complete with hinged net supports per pair

art. 680011 Gancio nylon blu per applicazione rete su porte calcetto acciaio (vite esclusa)
Nylon hook to apply net on steel soccer goals



art. 6802 Porte per calcetto in alluminio mobili, completamente smontabili cm 300x200
Aluminium futsal goals 300x200 cm, freestanding, complete with hinged net supports



art. 6820 Reti in nylon pesante ø 3 mm
Polyethylene nets for futsal goals, ø 3,5 mm, depth 100 cm

art. 590010 Gancio nylon blu per applicazione rete su porte calcio-calcetto alluminio
Nylon hook to apply net on aluminum soccer goals



art. 6821 Reti in nylon testurizzato, lavorato a mano ø 6 mm
Nylon nets for futsal goals, ø 6 mm, depth 100 cm



art. 6811 Coppia carrelli per il trasporto di una porta calcetto/pallamano
Pair of trolley for the transport of one futsal/handball goal



art. 6816 Porte per calcetto in acciaio, fisse con bussole, verniciate a fuoco, cm 300x200
Steel futsal goals 300x200 cm standing in ground sockets varnished net support



art. 6815 Porte per calcetto in acciaio, trasportabili, frontoni saldati sui pali verniciate a fuoco cm 300x200
Steel futsal goals 300x200 cm freestanding, complete with hinged varnished net supports



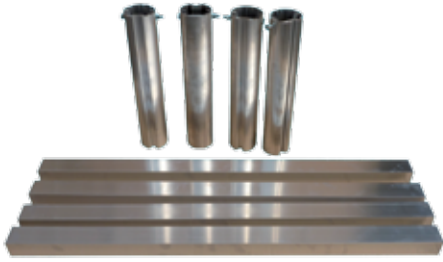

art. 6019 Kit di trasformazione da trasportabile a fissa per porte in alluminio sez. diam. 80 mm al paio
Kit sochets to change freestanding soccer goal in fixed per pair



art. 680011 Gancio nylon bianco per applicazione rete su porte calcio ridotte/calciotto acciaio (vite esclusa)
Nylon hook to apply net on steel soccer goals



art. 6809 Picchetto per ancoraggio a terra porte calcio e calciotto
Goal anchor



art. 6821 Reti in nylon testurizzato, lavorato a mano
Nylon nets for futsal goals, ø 6 mm, depht 100 cm



art. 6805 Sistema per spostamento di un paio di porte calciotto con ruote
Goal transporter system in steel with wheels



art. 6047 Sacco di appesantimento per zavorrare le porte, in pvc elettrosaldato, riempibile di acqua o sabbia, con tappo di chiusura.
Bag for ballast to apply to goals, made in pvc, filled in water or sand



art. 6804 Paletta segnalazione 5 falli in plastica
5 plastic player fouls



art. 6807 Vitone multiuso per ancoraggio a terra alt. cm 23
Multi purpose anchor for lawn



art. 6044 Contenitori per zavorra da applicare su porte da calcio mobili NON a norma UNI o sulle porte calciotto mobili. Zavorra esclusa.
Storage for ballast to apply to NO UNI freestanding soccer goals or freestanding futsal goals



Panchina allenatori modulare con struttura in alluminio 40x20 mm, copertura in policarbonato alveolare sp. 4 mm, sedute impilabili con struttura in acciaio zincato e doghe in alluminio anodizzato. La copertura e la seduta è composta da moduli da 1 metro.

Modular team shelter in aluminium construction 40x20 mm, cell-like polycarbonate panels thickness 4 mm, stackable seats made with galvanized steel and beams in anodized aluminium. 1 meter modular.

art. 6240 Paio fianchi

Pair of sides

art. 6241 Copertura e sedute modulo da 1 metro

1 meter cover and seat

art. 6242 Modulo da 1 metro copertura e sedute con doghe in legno

1 meter cover and seat with wood beams



art. 6243 Pedana a terra in alluminio per le sedute delle panche modello "Light" da 2 metri

Platform in aluminium for the seats of team shelter model "Light" 2 meters long





art. 6291 Panchina struttura in alluminio trasportabile su ruote ricoperta in policarbonato alveolare

Freestanding team shelter aluminium construction, portable on wheels, cell-like polycarbonate panels



art. 6200 Panchina a modulo, serie economica, rivestimento in policarbonato alveolato telaio verniciato

Tem shelter, economical series, panels in cell-like polycarbonate painted frame



Modulo tribuna da 2 metri a 3 file in acciaio verniciato, ribaltabile e trasportabile con ruote

Compact stand use 2 mt with 3 steps in painted steel, foldable and mobile on wheels

art. 8562 Seduta composta da doghe in alluminio anodizzato con inserto in pvc colore blu.

Seat with beams in anodized aluminium with film in PVC in blue colour



PALLAVOLO

volleyball







art. 5013 Impianto periscopio in alluminio a norma F.I.V.B. - "All aluminium"

Periscopic system in aluminium in compliance F.I.V.B. - "All aluminium"

art. 5009 Impianto pallavolo in alluminio meccanismi interni "All aluminium"

Volleyball system in aluminium with internal mechanisms "All aluminium"





art. 5002 Impianto trasportabile con bussole zincato con tendirete ø 70 mm

Mobile volleyball system with sockets, galvanized, with net extension ø 70 mm



art. 5525 Protezione da esterno per impianti pallavolo/ beach-volley monopalo

Protective pad for item 5002-5005-5510-5512



art. 5003 Impianto trasportabile con bussole zincato a periscopio ø 70 mm a norma F.I.P.A.V.

Mobile periscopic volleyball system with sockets, galvanized ø 70 mm



art. 5005 Impianto trasportabile con bussole zincato ø 100 mm

Mobile volleyball system with sockets, galvanized ø 100 mm



art. 5417 Protezione imbottita per impianto pallavolo a parete ns. art. 5010

Protective pad for art. 5010



art. 5010 Impianto a parete con tendirete zincato

Wall system, galvanized



art. 5029 Impianto a traliccio in alluminio meccanismi interni, tiranti ridotti, piastra antitorsione
Mobile volleyball system in aluminium, with internal mechanisms, with antitorsion plate laser cut, can be dismantled



art. 5026 Impianto a traliccio sgancio rapido
Steel competition volleyball posts rapid unhook

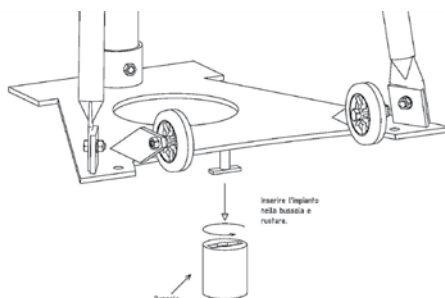

art. 5412 Protezioni in gomma per impianto pallavolo a traliccio art. 5029
Protective pads for art. 5029



art. 5020 Impianto a traliccio in acciaio anche uso tennis con ruote dotato di piastra antitorsione tagliata al laser
Mobile volleyball system in steel, with wheels with antitorsion plate laser cut

art. 5527 Protezione da esterno per impianti pallavolo a traliccio
Protective pad for art. 5020-5025



art. 5025 Impianto a traliccio in acciaio mod. Torneo
Mobile volleyball system in steel, with wheels, mod. Torneo



art. 5021 Impianto a traliccio in acciaio con dispositivo porta zavorra dotato di piastra antitorsione tagliata al laser, smontabile

Mobile volleyball system in steel with ballast device with antitorsion plate laser cut, can be dismantled



art. 5304 Impianto minivolley-superminivolley zavorrato, trasportabile su ruote, modello Hobby

Minivolley-superminivolley system ballasted, trasportable on wheels, model Hobby



art. 5022 Impianto pallavolo trasportabile su ruote con basamento polivalente grande. I tenditori applicati sugli impianti sono muniti di sicurezza antigancio

Freestanding portable volleyball system, with ballast and wheels. Stretching devices applied on systems are complete with safety device against release



art. 5300 Impianto volley-minivolley-superminivolley

Mobile volley-minivolley-superminivolley system, ballasted



art. 5404 Palchetto per arbitro pallavolo, in alluminio

Volleyball referee's stand, made in aluminium



art. 5439 Tappo di chiusura bussole con sistema di chiusura rapida

Cup for sockets



art. 5407 Palchetto per arbitro in piedi chiudibile piano in alluminio chiudibile a libro

Volleyball referee platform, closing to book



art. 5409 Palchetto per arbitro pallavolo piedi-seduto con ruote, norme F.I.P.A.V. supporto sedile con sedile sganciabile

Professional referee's stand standing-seated in compliance with regulations F.I.P.A.V., adj. Height, mobile with wheels



art. 5403 Palchetto per arbitro pallavolo piedi-seduto oleodinamico, norme F.I.P.A.V. spostabile con ruote completo di protezioni totali

Professional referee's stand standing-seated in compliance with compliance F.I.P.A.V. - Height setting with hydraulic system

art. 5408 Palchetto per arbitro in piedi chiudibile piano in alluminio chiudibile a libro con ruote

Volleyball referee platform, folding, mobile with wheels



art. 5057 Net-Tool - Sistema di elastici da applicare alla rete
Net-Tool - Elastic to apply to the net



art. 5054 Jump tester elettronico - Training Tester
Electronic jump tester - Training tester





art. 5050 Basamento zavorrato supporto attrezzi smontabile
Ballasted base for tools support, can be dismantled

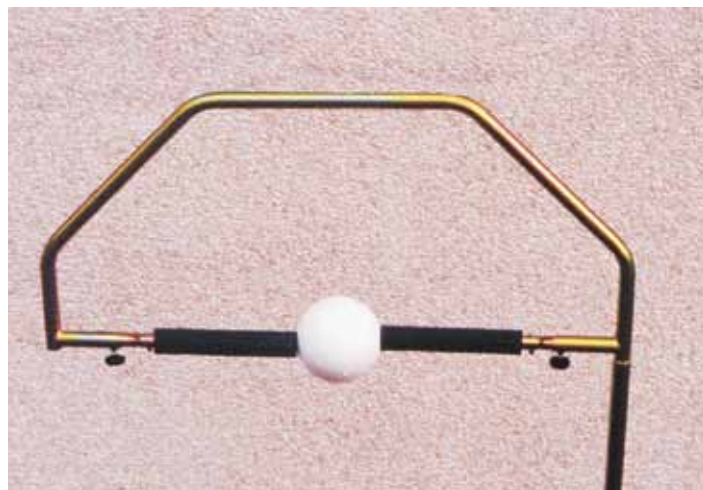

art. 5060 Spike con ganasce per pallone volley-minivolley
(escluso basamento)
Spike with jaws for ball volley-minivolley (base excluded)

art. 5050 Basamento zavorrato supporto attrezzi smontabile
Ballasted base for tools support, can be dismantled



art. 5051 Jump tester (escluso il basamento)

Jump tester (base excluded)

art. 5050 Basamento zavorrato supporto attrezzi smontabile

Ballasted base for tools support, can be dismantled



art. 5071 Riduzione per ball-catcher

Reduzione for ball-catcher

art. 5070 Ball-catcher (escluso basamento) 70x70 cm

Ball-catcher (base excluded) 70x70 cm

art. 5080 Retone per ball-catcher

Net for ball-catcher

art. 5050 Basamento zavorrato supporto attrezzi smontabile

Ballasted base for tools support, can be dismantled



art. 5081 **Simulatore di muro completo su ruote autobloccanti**

Wall simulator with self locking castors



art. 5082 **Simulatore di muro portatile in lega leggera completo di protezioni imbottite**

Mobile wall simulator in light aluminium alloy complete with protection pads



art. 5101 **Pallone Molten soft-touch ufficiale serie A1-A2**

Ball Molten soft-touch official series A1-A2



art. 4091 Pannello elastico "palla indietro" multiuso, regolabile in altezza e orientabile con incremento della velocità della palla. (escluso basamento)

Elastic panel "back ball" multi purpose, height adjustable and rotary with greater speed of the ball. (base excluded)



art. 4385 Basamento con doppia zavorra, supporto attrezzi smontabile (ideale per l'art. 4091)

Base with double ballast, tools support taht can be dismantled (ideal for item 4091)



art. 5084 Barra con elastici a resistenza regolabile

Bar with elastic adjustable resistance

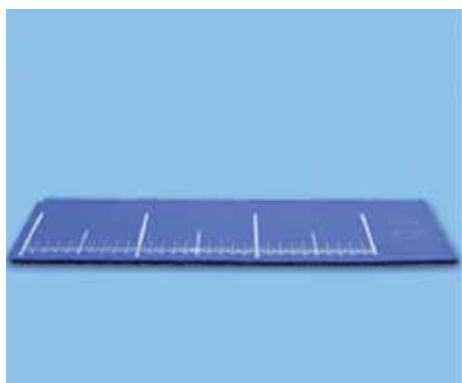

art. 5438 Mat test lunghezza cm 370 larghezza cm 100

Mat test length cm 370 width cm 100



art. 5109 Pallone Molten training V5M4000 pelle colorato ottima qualità

Ball Molten training V5M4000 leather, coloured, high quality



art. 5106 Pallone Molten ultra touch V5M1500 colorato

Ball Molten ultra touch V5M1500 coloured



art. 5069 Spike catcher, rete inclusa
Spike catcher, net included



art. 5413 Protezioni in gomma per impianto pallavolo a periscopio art. 5013
Protective pads for item 5013



art. 5431 Protezione imbottita per seggiolone art. 5543 - 5407
Protection pads for stand item 5543 - 5407



art. 5428 Protezione imbottita per seggiolone art. 5543 - 5407 modello economico
Protection pads for stand item 5543 - 5407 economic model



art. 5430 Segnalatore per time-out a batteria con sirena
Mobile acoustic and luminous signals for time-out

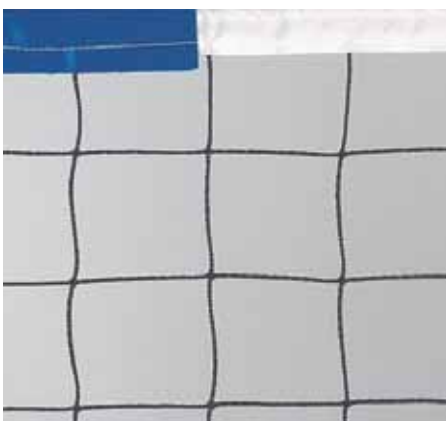

art. 5207
Rete leggera senza nodo completa di nastro e cavo
Light net without knot complet with band and cable



art. 5205
Rete pesante con nodo completa di nastro e cavo
Heavy net with knot complete of band and cable



art. 5202
Rete A NORMA F.I.V.B. mondiale extra con nastro superiore e inferiore a bande porta antenne mobili
Net in compliance with regulation F.I.V.B. mondial extra



art. 5201
Rete torneo super con nodo bande mobili
Tournament net super with and mobile hands



art. 5210 Antenne in fibra per rete pezzo unico

Volleyball antennae in fibre, for one net, single piece



art. 5202 Rete a norma F.I.V.B. mondial extra con nastro superiore e inferiore e bande porta antenne mobili

Net in compliance with regulations F.I.V.B. mondial extra



art. 5212 Tasche porta-antenne in nylon

Antennae pockets in nylon



art. 5400 Argano tendirete in ottone di ricambio con uncino

Tensioning winch in brass, as spare part, with hook



art. 5401 Tenditore a scatto con sicurezza completo di cinghia

Spring takeup with safety device



art. 4308 Panche per atleti e riserve con poggiaschiena tubo ø 40, 3 mt

Reserves and athletes bench with backrest ø 40, 3 mt



art. 1047 Carrello portapalloni in acciaio verniciato pieghevole 80x55x60 cm

Ball transporter, in steel, can be folded 80x55x60 cm



art. 1045 Carrello portapalloni in acciaio, con sacca, chiusura ad ombrello 60x60x90 cm

Ball transporter in steel, with bag, closing to umbrella 60x60x90 cm



art. 5434 Segnapunti manuale girevole a 4 cifre meteore, su piantana

Scoreboard with 4 digits, structure in steel with ballasted base



art. 5414 Segnapunti da tavolo con numerazione bifacciale da 0 a 50 e segnalazione time-out

Manual table scoreboard, number on 2 faces from 0 to 50 volley with time-out pocket



art. 4318 Segnapunti manuale girevole a 6 blocchi plastificati, su piantana

Scoreboard plastic flashcards with ballasted base



art. 5427 Serie palette in plastica per sostituzione giocatori 18 pezzi

Set of numbered plastic boards for substitution player



art. 5437 Porta palette a 18 posti. Costruito il legno

Wooden support for numbered plastic boards

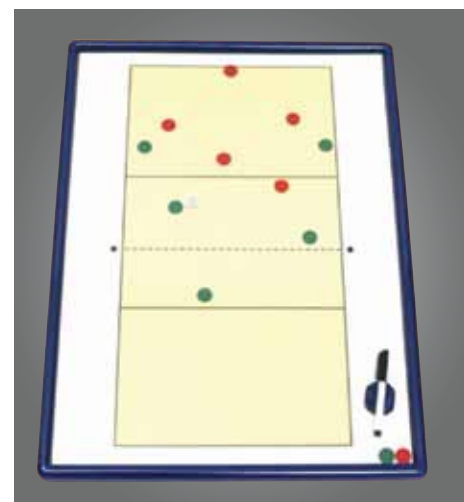

art. 5435 Lavagna magnetica volley cm 90x60 con pedine

Magnetic tactic-board for volleyball cm 90x60



BEACH VOLLEY



VIVISPORT



Fornitore tecnico ufficiale campionati mondiali Beach Volley maschili e femminili 1999-2000-2001 Tappe italiane World Tour 2006 - 2007 - 2009 - 2010 - 2011.

Fornitore tecnico ufficiale campionati italiani Beach Volley maschili e femminili 2001 - 2002, femminili 2007 - 2008 - 2009 - 2010 - 2011.





art. 5500 Impianto in acciaio a periscopio con bussola tridimensionale a norma F.I.V.B. dotato di 6 pali in legno mod. Montecarlo

Professional periscopic beach-volley system, with sockets



art. 5545 Seggiolone arbitro beach-volley monopalo
Telescopic beach-volley referee's stand, made in steel and aluminium

art. 5526 Protezione imbottita per seggiolone art. 5545
Protection pads for stand item 5545





art. 5512 Impianto in acciaio zincato a periscopio come da norm. F.I.P.A.V.

Hot galvanized steel beach-volley periscopic system, with sockets



art. 5404 Palchetto per arbitro pallavolo/ beach tennis, in alluminio

Volleyball/Beach tennis referee's stand, made in aluminium



art. 5510 Impianto in acciaio zincato a caldo per esterni. Adatto anche per il beach-tennis.

Hot galvanized steel beach-volley system, with sockets

art. 5525 Protezioni da esterno per impianti pallavolo/ beach-volley monopalo

Protective pad for item 5002 - 5005 - 5510 - 5512



art. 7569 Seggiolone per arbitro tennis in alluminio

Tennis referee stand in painted aluminium

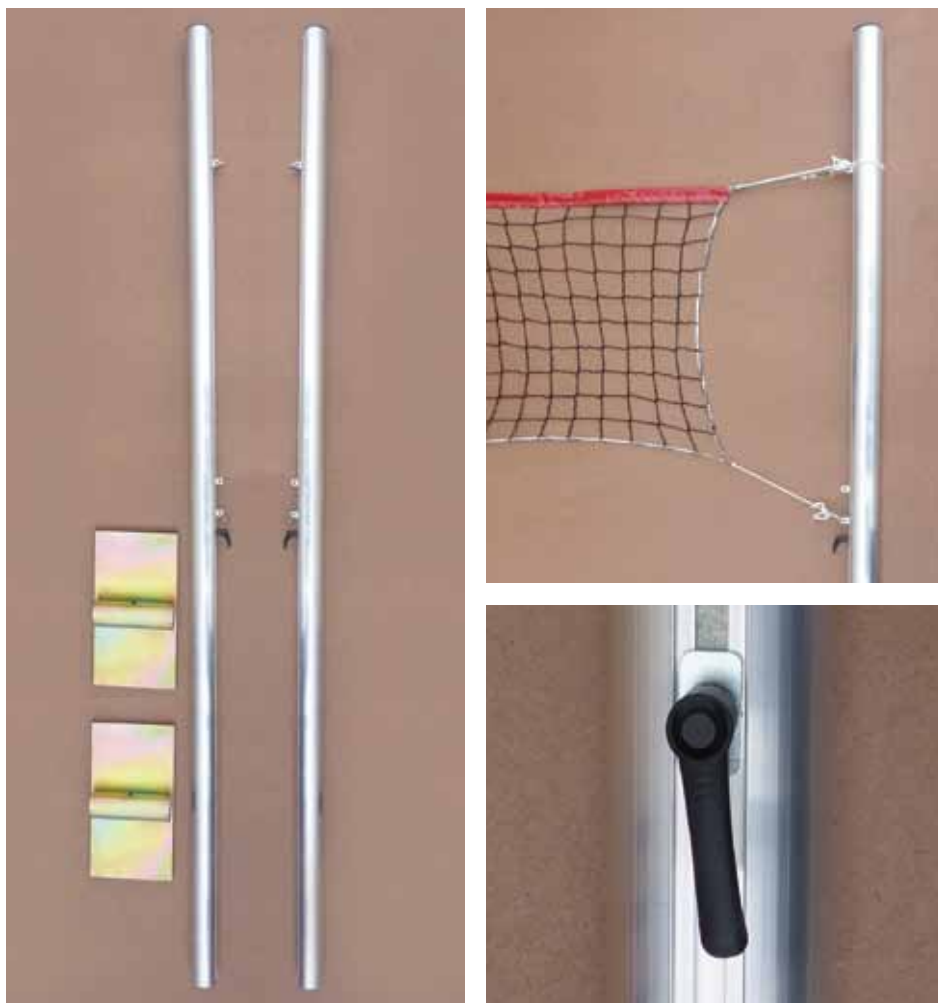

art. 5513 Impianto beach volley in alluminio, tubo \varnothing 80 mm, senza bussole
Aluminium beach volley system, tube \varnothing 80 mm, without sockets



art. 5516 Impianto beach volley economico con picchetti e cavi
Economical volleyball system with sliding and pickets \varnothing 40 mm



art. 5515 Impianto tempo libero con rete e picchetti
Fun beach volley system with net and bag





art. 5543 Seggiolone arbitro chiudibile piano in alluminio antiscivolo
Beach-volley referee platform, fending

art. 5428 Protezione imbottita per seggiolone art. 5543 - 5407 modello economico
Protection pads for stand item 5543 - 5407 economic model

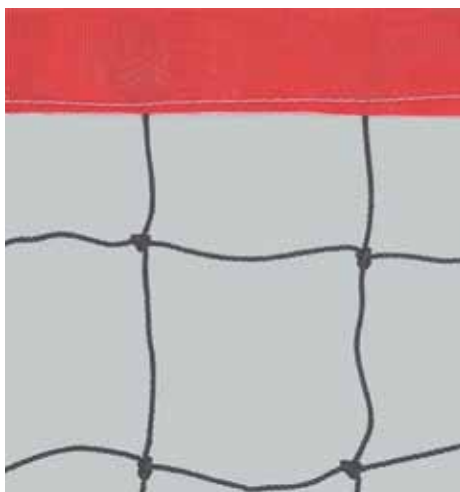

art. 5530 Rete con nastro colorato regolamentare tipo pesante
Beach-volley net, strong model



art. 5531 Rete con nastro colorato professionale, con nodo doppiok, nastro in pvc
Professional beach-volley net with coloured edges lines, with double knot, edge line in PVC



art. 5511 Trivella in acciaio per posizionamento
Steel drill to place system



art. 5414 Segnapunti da tavolo con numerazione bifacciale da 0 a 50 e segnalazione time-out
Manual table scoreboard, number on 2 faces from 0 to 50 volley with time-out pocket



art. 5551 Pallone beach-volley Mikasa VLS 200 uff. F.I.V.B.
Beach-volley ball Mikasa VLS 200 uff. F.I.V.B.



art. 5540 Nastro segnacampo completo di ancoraggi set per 1 campo
Set of beach-volley courtline, with pickets set for 1 court



art. 5431 Protezione imbottita per
 seggiolone art. 5543 - 5407
*Protection pads for stand
 item 5543 - 5407*



art. 5520 Campo sintetico per beach-volley
Synthetic floor for beach-volley



BEACH SOCCER



VIVISPORT





art. 6900 Porte in alluminio 5,5x2,2 mt, mobili, colore giallo sez. ø 80 mm

Yellow aluminium beach soccer goals, 5,5x2,2 mt freestanding section ø 80 mm

art. 6905 Reti per porte regolamentari polietilene stab. raggi UV

Nets in polyethylene for beach soccer goals



art. 6406 Drappo fluo per aste calcio d'angolo dim. cm 60x40
Spare nylon flag for corner pole cm 60x40



art. 6908 Set 10 pali per angolo snodati con bussole, drappi e clips
Set of 10 flexible plastic corner poles, with sockets, flags, clips



art. 6901 Set 4 pali angolo fisso con bussole, bandierine e clips
Set of 4 fixed plastic corner poles, with sockets, flags, clips



art. 5511 Trivella in acciaio per posizionamento
Steel drill to place system



art. 6402 Fettuccia delimitazione campo h. 8 cm (per 1 campo)
Set of beach-volley courtline, with pickets

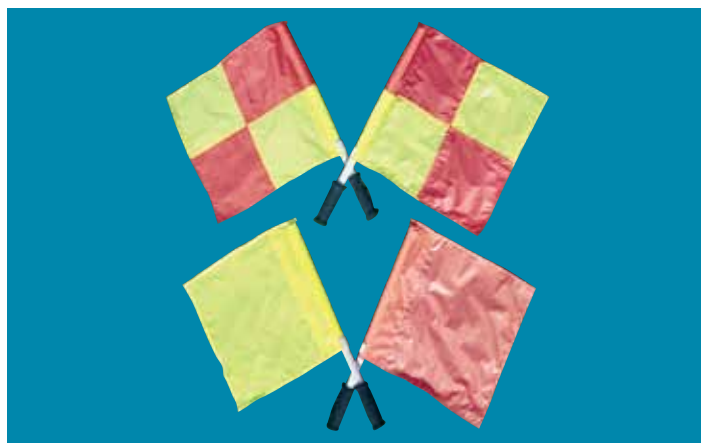

art. 6405 Set 2 aste guardialinee complete di bandierine
Set of 2 linesman flags with plastin handle

art. 6407 Drappo a scacchi per aste guardialinee dim. cm 40x40
Spare nylon flag for linesman flag cm 40x40

BEACH TENNIS



VIVISPORT



art. 5500 Impianto in acciaio a periscopio con bussola tridimensionale a norma I.F.B.T. dotato di 6 pali in legno
Professional periscopic beach-volley system, with sockets



art. 5516 Impianto pallavolo economico con picchetti e cavi, rete esclusa

Economical volleyball system with sliding and pickets without net ø 40 cm



art. 5404 Palchetto per arbitro pallavolo, in alluminio

Volleyball referee's stand, made in aluminium



art. 5510 Impianto in acciaio zincato a caldo per esterni.
Adatto anche per il beach-tennis.
Hot galvanized steel beach-volley system, with sockets

art. 5525 Protezioni da esterno per impianti pallavolo/beach-volley monopalo paio
Protective pad for art. 5002 - 5005 - 5510 al paio



art. 5545 Seggiolone arbitro beach-volley monopalo
Telescopic beach-tennis / beach-volley referee's stand, made in steel and aluminium

art. 5526 Protezione imbottita per seggiolone art. 5545
Protection pads for stand item 5545



art. 5540 Nastro segnacampo completo di ancoraggi set per 1 campo
Set of beach-volley courtline, with pickets set for 1 court



art. 5429 Rete beach-volley - racchettoni, maglia 40x40 mm
Beach-tennis / Beach-volley net, mesh 40x40 mm

PALLACANESTRO

basket



VIVISPORT





art. 4279 Dispositivo anticaduta per impianti basket a soffitto al paio

Fall arrester device for roof basket system



art. 4270 Impianto basket mobile a soffitto, tabellone in legno

Roof mobile basket system, wood backboard



art. 4290 Impianto manuale reg. a molle omologato F.I.B.A. MacShot
Manual system, spring adjustable, F.I.B.A. approved







art. 4285 Impianto oleodinamico elettrico mod. Zeus sbalzo 320 cm
Mobile electrical system, mod. Zeus ext. arm 320 cm



art. 4282 Impianto oleodinamico manuale mod. Zeus sbalzo 225 cm
Manual mobile system, mod. Zeus ext. arm 225 cm



art. 4271 Impianto basket/minibasket a losanga

Wall basket system, foldable



art. 4265 Impianto basket pieghevole a libro, tabellone in legno sbalzo 320 cm

Wall basket system foldable, wood backboard ext. arm 320 cm



art. 4277 Dispositivo utilizzo impianti per minibasket modello super profess.

Side-folding type height adjustable from basket to minibasket, model extra profess.

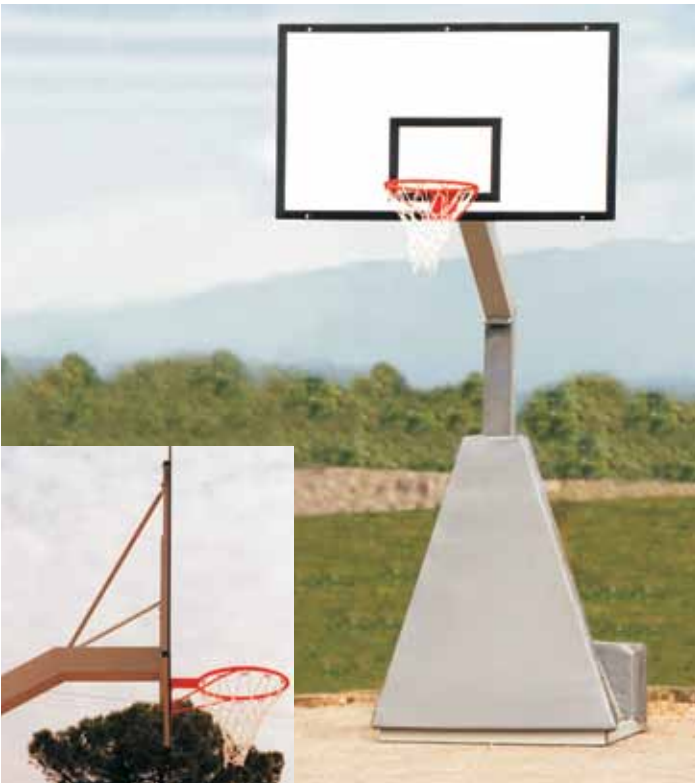

art. 4248 Impianto monotubo trasportabile, tabellone in legno.
Mod. College sbalzo 165 cm
*Mobile basket system, wood backboard Mod. College
ext. arm 165 cm*

art. 4267 Protezione per impianti monotubo trasportabile art. 4248
Mobile system pad for item 4248



art. 4252 Impianto basket a traliccio in acciaio zincato, smontato,
trasportabile sbalzo 225 cm con tabellone in legno
*Basket system in hot galvanized steel, dismantled,
mobile ext. arm 225 cm with wood backboard*



art. 4202 Impianto monotubo zincato caldo rotondo tabelloni
lamiera sbalzo 160 cm cm135x90 canestri e retine
zincati sbalzo 165 cm
*Outdoor basketball system, round posts hot galvanized,
ext. arm 165 cm steel backboards ext. arm 165 cm*



art. 4400 Protezione antinfortunistica per impianto basket
art. 4201-4200-4202
Safety pad for basket system item 4201-4200-4202



art. 4201 Impianto monotubo con tabelloni in resina melaminica sbalzo 165 cm struttura smontabile con piastre di collegamento
Outdoor basketball system, posts hot galvanized, laminated backboard arm 165 cm

art. 4200 Impianto monotubo con tabelloni in legno sbalzo 165 cm struttura smontabile con piastre di collegamento
Outdoor basketball system, posts hot galvanized, wood backboard

art. 4400 Protezione antinfortunistica per impianti basket art. 4201-4200-4202
Safety pad for basket system item 4201-4200-4202



art. 4223 Mezzo impianto basket/minibasket mod. Streetball, pieghevole, altezza canestro regolabile da 210 a 305 cm, tabellone rettangolare 110x90 cm, zavorra non inclusa

Portable half minibasket system, height adjustable from cm 210 to 305 model Streetball



art. 4224 Mezzo impianto minibasket a norme UNI-EN 1270, con zavorra riempibile

Portable half minibasket system, height adjustable from cm 120 to 261



art. 4002 Canestro su colonna con tabellone cm 114x73 basamento smontabile completamente antinfortunistico sbalzo 30 cm

School basket post with resin backboard cm 114x73 safety case, can be dismantled ext. arm 30 cm

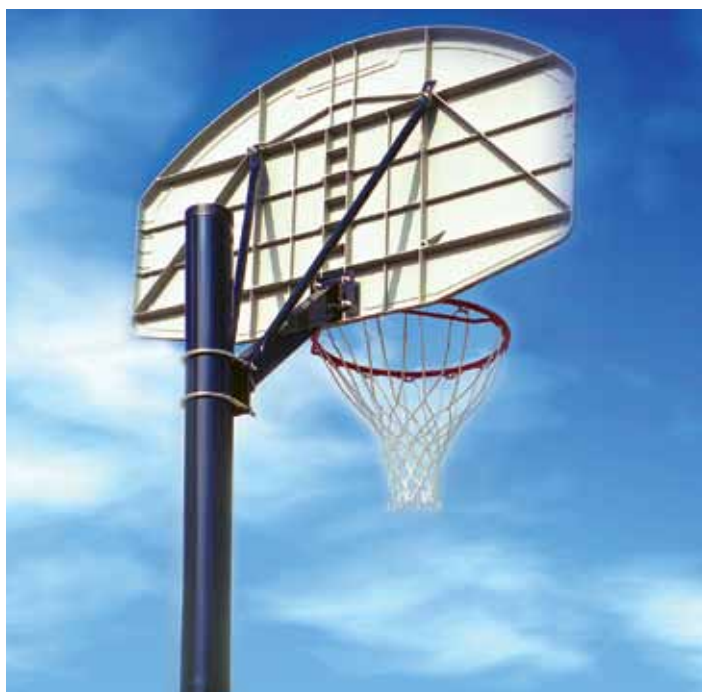

art. 4225 Mezzo impianto basket/minibasket con zavorra riempibile altezza reg. manualmente mod. Chicago

Portable half basket/minibasket system, height adjustable, fiberglass backboard, model Chicago

art. 4226 Mezzo impianto basket/minibasket con zavorra riempibile nuovo sistema a scatto per posizionamento altezza tabellone mod. Los Angeles

Portable basket/minibasket half system, easy height adjustment, fiberglass backboard, model Los Angeles



art. 4229 Mezzo impianto basket/minibasket tabelloni plexiglass mod. Orlando

Portable basket/minibasket half system, easy height adjustment, plexyglass backboard, model Orlando



art. 4230 Mezzo impianto basket/minibasket su ruote autobloccanti mod. Scuola

Mobile basket/minibasket half system, height adjustable, fiberglass backboard





art. 4231 Mezzo impianto basket minibasket su monotubo da 70 mm zincato
Half streetball basket/minibasket system, hot galv



art. 4232 Mezzo impianto basket minibasket su monotubo verniciato da 80 mm modello "Green"
Half streetball basket/minibasket system, painted, with sockets



art. 4263 Impianto basket/minibasket a parete tabellone ovale cm 114x73 sbalzo cm 60
Wall basket/minibasket system, oval backboard cm 114x73 ext. arm cm 60



art. 4268 Mezzo impianto basket a parete fisso, tabellone ovale cm 114x73 sbalzo 20 cm
Half basket wall system, fixed, oval backboard cm 114x73 ext. arm 20 cm



art. 4119 Pallone Molten BGE7 cuoio sintetico mod.school
Basket ball, synthetic leather, Molten BGE7



art. 4125 Pallone Molten BGM7 in pelle sintetica
Basket ball, synthetic leather, Molten BGM7



art. 4001 Canestro su colonna scolastico base antinfortunistica super rinforzata con piastra
School basket post with safety base extra strong, with plate

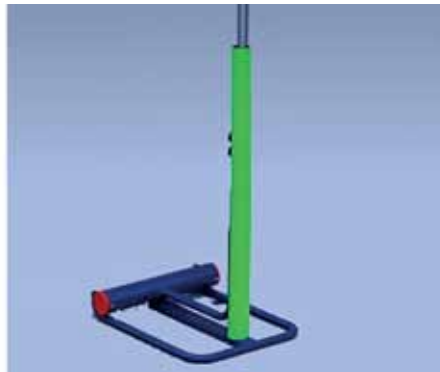

art. 4009 Protezione imbottita per impianto 4001-4002
Post pad for systems 4001-4002



art. 4227 Protezione imbottita per art. 4225/4226
Post pad for art. 4225/4226



art. 4117 Pallone Molten BGR7 gomma giugiario
Basket ball, rubber, Molten BGR7



art. 4116 Pallone Molten BGR6 azzurrina giugiario
Basket ball, size 6, Molten BGE6



art. 4124 Pallone Molten BGR5 minibasket gomma
Ball Molten BGR5 minibasket in rubber



art. 4276 Dispositivo utilizzo impianti per minibasket completa di asta per la regolazione
Side-folding type height adjustable from basket to minibasket pair complete with adjustment pole



art. 4052 Tabellone in plexiglass con telaio 180x105 cm
Plexyglass backboard with frame 180x105 cm



art. 4055 Tabellone in acciaio mod. americano cm 135x90,
trattato e verniciato
*Steel backboard mod. american cm 135x90, treated and
 painted outdoor use*



art. 4054 Tabellone in cristallo sp. mm 6+8 con telaio 180x105 cm
Glass backboard thickness mm 6+8 with frame 180x105 cm



art. 4056 Tabellone basket cm 112x73 con canestro e retina
Backboard cm 112x73 with basket and net



art. 4050 Tabellone in legno bilaminato 180x105 cm
Bilaminated wood backboard 180x105 cm



art. 4051 Tabellone in resina melaminica 180x105 cm
Laminated fibreglass backboard 180x105 cm



art. 4003 Canestro basket completo di rete mod. Import
Basketball basket complete with net mod. Import



art. 4004 Canestro in acciaio zincato a caldo per esterni,
con piastra di rinforzo, ultra resistente
*Outdoor hot galvanised steel basket with reinforcing plate,
very strong*



art. 4005 Canestro regolamentare
Regulation basket



art. 4008 Canestro in acciaio verniciato, con piastra di rinforzo,
ultra resistente
Painted basket with reinforcing plate, very strong



art. 4016 Canestro in acciaio verniciato, cerchio di tondo pieno, con
piastra di rinforzo, ultra resistente, a norma UNI EN 1270
*Painted basket with reinforcing plate and circle made with
full iron, very strong in compliance with UNI EN 1270 norms*



art. 4007 Canestro regolamentare pesante
Heavy regulation basket



art. 4010 Canestro reclinabile sganciabile regolamentare
a 3 molle
Flex goal regulation basket, unhooked, 3 springs



art. 4015 Canestro reclinabile a norme F.I.B.A. sistema sgancio
a molle ISO 10243
*Flex goal basket, in compliance with F.I.B.A. regulations,
springs releasing system ISO 10243*



art. 4013 Canestro reclinabile economico ad 1 molla con retina inclusa

Flex goal basket, 1 spring, with net included - Economic model



art. 4014 Canestro reclinabile sganciabile omologato F.I.B.A. con certificato

Flex goal basket, unhooked, F.I.B.A. approved with certificate



art. 9902 Protezioni murali a pannello

Indoor protections for wall



art. 4082 Protezioni sottocanestro in poluretano, a norma FIBA

Backboard pads in polyurethane, in compliance with regulations FIBA





art. 4309 Protezione per panche riserve e tavolo giuria in alluminio
Aluminium protection for reserves benches and judges table



art. 4325 Tavolo per giudici in alluminio carenato con ruote autobloccanti e protezioni totali
Aluminium careened judges' table with self blocking castors and protection on upper border



art. 4307 Panca per atleti e riserve con possibilità di applicazione art. 4309
Reserves and athletes bench with possibility to apply to item 4309

art. 4309 Protezione per panche riserve e tavolo giuria in alluminio
Aluminium protection for reserves benches and judges table



art. 4091 Pannello elastico "palla indietro" multiuso, regolabile in altezza e orientabile

Elastic back ball panel, multi purpose, height adjustable and rotary with greater speed of ball (escluded base)

art. 4385 Basamento con doppia zavorra, supporto attrezzi smontabile (ideale per l'art. 4091)

Base with double ballast, tools support that can be dismantled (ideal for item 4091)



art. 4090 Supporto basket per riporto del pallone

Ballasted support for back ball



art. 4308 Panche per atleti e riserve con poggiaschiena tubo 40, 3 mt

Reserves and athletes bench with backrest tube 40, 3 mt



art. 4118 Pallone Molten Giugiario BGG/ uffì a1-a2

Competition basket ball, Molten BGF7

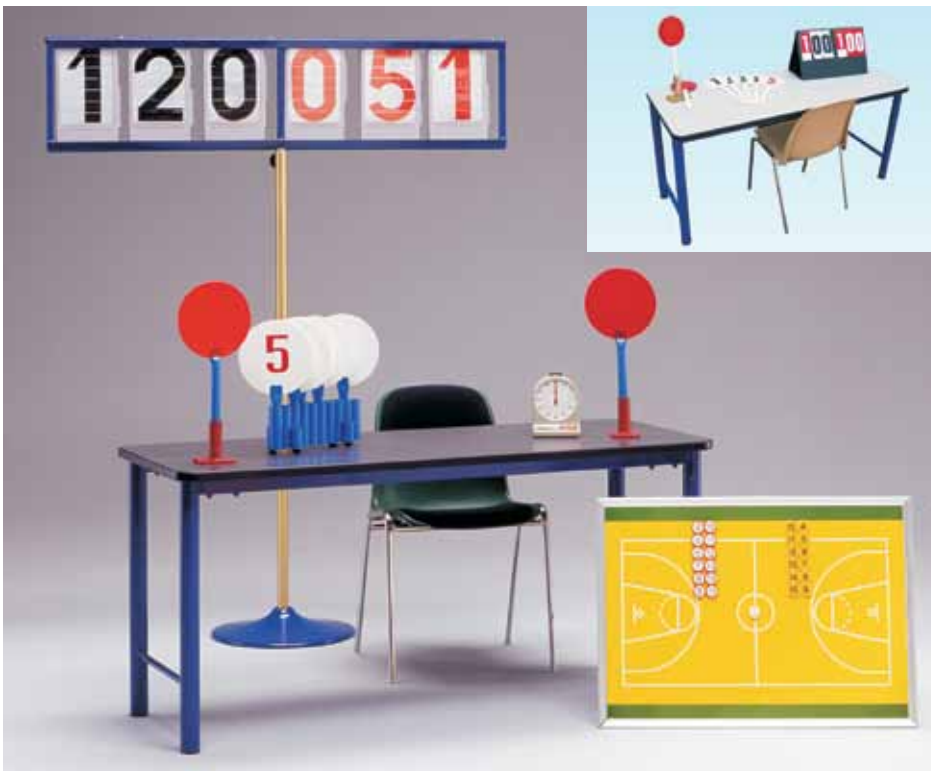

art. 4382 Segnapunti manuale girevole a 6 tabelle meteore, su piantana

Scoreboard weatherproof boards with ballasted base

art. 4302 Lavagna magnetica da parete con pedine cornice alluminio 60x90 cm

Wall magnetic blackboard with pieces, aluminium frame 60x90 cm

art. 4305 Serie palette giudici basket

Series of hand signal sticks for basket judges

art. 4316 Tavolo per giudici smontabile 150x60xh76 cm

Judges' table dismantled 150x60xh76 cm

art. 4313 Sedia plastica imbottita

Stuffed chair in steel / plastic



art. 4318 Segnapunti manuale girevole a 6 blocchi plastificati, su piantana

Scoreboard plastic flashcards with ballasted base



art. 4304 Paletta con freccia per il possesso alternato munita di base in acciaio verniciato

Hand signal stick with arrow for alternate possession with base in painted steel



art. 4300 Cronometro da tavolo

Table chronometer



art. 8438 Indicatore luminoso di possesso alternato conf. norme F.I.B.A. cm 35x20

Ball possession electronic marker

TENNIS



VIVISPORT

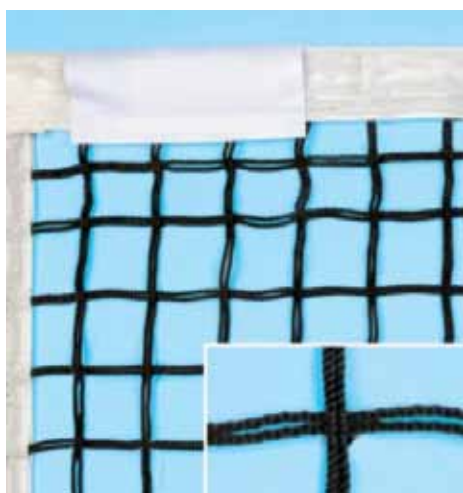

art. 7507 Impianto tennis in acciaio
spostabile su ruote,
contrappesi esclusi

*Freestanding tennis system
made in steel, mobile on wheels
excluding counter weight*

art. 7521 Rete in nylon torneo special
match completa di cavo
acciaio

*Net in nylon tournament, special
match complete with steel cable*



art. 7500 Pali tennis sezione quadra 80x80 mm

Tennis posts made in steel, square section 80x80 mm, with ground sockets

art. 7501 Pali tennis sezione rotonda ø 90 mm

Tennis posts made in steel, round section ø 90 mm, with ground sockets

art. 7505 Pali tennis in alluminio sezione rotonda ø 120 mm

Tennis posts in aluminium, round section ø 120 mm, with ground sockets



art. 7506 Impianto tennis alluminio meccanismi interni

Tennis posts all aluminium oval section 120x100 mm, internal mechanisms



art. 7503 Pali tennis per palestra sezione quadra 80x80 mm

Tennis posts for gymnasium, made in steel, square section 80x80 mm

art. 7501 Pali tennis sezione rotonda ø 90 mm

Tennis posts made in steel, round section ø 90 mm, with ground sockets



art. 7569 Seggiolone per arbitro tennis verniciato, alluminio
Tennis referee stand in painted aluminium



art. 7562 Seggiolone per arbitro tennis verniciato, completo
Tennis referee stand in painted steel



art. 7585 Tabellone elettronico per il tennis
Electronic scoreboard for tennis



art. 7540 Centro rete con gancio e fibbie
Polyester center strap for tennis net

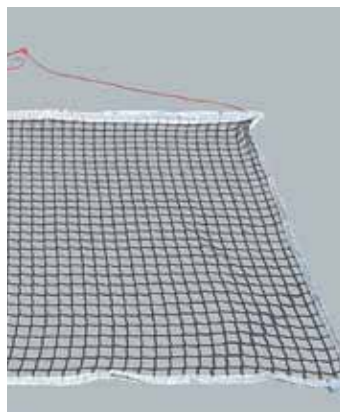

art. 7548 Rete livellamento campo da trascinare cm 200x150 con guida in ferro
Court net levelling to stretch cm 200x150 with iron rail



art. 6404 Impianto minitennis/calcio-tennis trasportabile economico con rete e sacca lunghezza mt 3 altezza cm 91,5
Minitennis/soccer-tennis system, portable, economical, with net and bag 3 mt long, 91,5 cm height



art. 4091 Pannello elastico "palla indietro" multiuso, regolabile in altezza e orientabile con incremento della velocità della palla (escluso basamento)

Elastic back ball panel, multipurpose, height adjustable and rotary with greater speed of ball (excluded base)



art. 7542 Cestino in metallo zincato raccogli palle

Ball retriever made from galvanised steel wire



art. 7549 Rete separazione campo tennis in polietilene, colore verde maglia 45x45 mm

Net separation tennis game in polyethylene mesh 45x45 mm



art. 9972 Palmare in legno con elastico per attività ludico motorie

Go back in wood with elastic

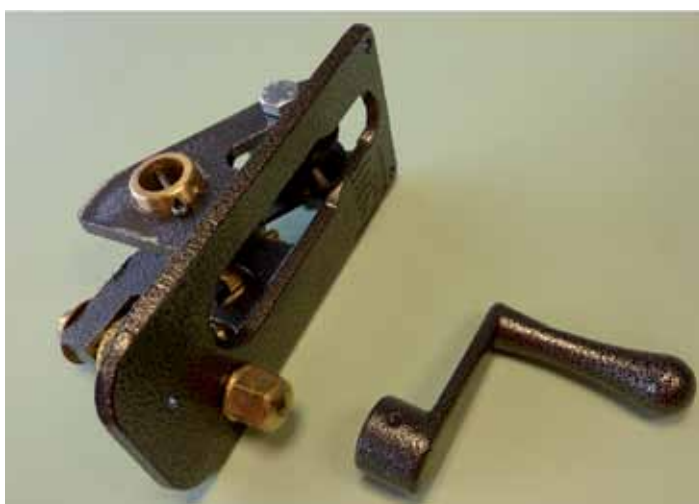

art. 7541 Argano tennis sezione piatta in ottone con maniglia estraibile

Net tension mechanism, for square section systems



art. 7544 Argano tennis sezione rotonda in ottone con maniglia estraibile

Net tension mechanism, for round section systems

RUGBY PALLAMANO BADMINTON TENNIS TAVOLO

handball

tennis table







art. 8002 Coppia porte in alluminio altezza 11,00 metri fuori terreno

Pair of goals in aluminium. Height 11,00 m



art. 8001 Protezioni per pali

Post pads



art. 6233 Panchina struttura in acciaio zincato a caldo, ricoperta in policarbonato trasparente sp. mm 3, profilato mm 50x30, sedute a scocche in polipropilene (mod. curvo) mt 5

Team shelter steel hot galvanised construction, cell-like polycarbonate panels thickness mm 4, construction mm 50x30, body work in polypropylene (curved model) mt 5



art. 6403 Set 4 pali angolo snodato con bussole, bandierine, clips

Set of 4 flexible plastic corner poles with sockets, flags, clips



art. 6401 Set 4 pali angolo fisso con bussole, bandierine, clips

Set of 4 fixed plastic corner poles with sockets, flags, clips



art. 8010 Scudo imbottito, in similpelle con scalino. Dimensioni cm 75x35x15

Padded shield for rugby, dimensions 75x35x15 cm



art. 7001 Porte pallamano in alluminio, mobili, completamente smontabili 3x2 mt

Freestanding handball goals in aluminium 3x2 mt



art. 6812 Sistema di fissaggio rapido a terra con uncino per porte calcetto o pallamano. Il sistema comprende n. 1 staffa con un uncino completo di pomello di regolazione

Quick fixing system on the ground with hook for futsal and handball goals Socket not included



art. 6813 Bussola per sistema di fissaggio a terra con uncino art. 6812

Socket for item 6812



art. 6805 Sistema per spostamento di un paio di porte calcetto con ruote

Goal transporter system in steel with wheels



art. 7015 Set 4 protezioni per i pali delle porte da pallamano

Set of 4 pads for handball goals posts



art. 6811 Coppia carrelli per il trasporto di una porta calcetto/pallamano

Pair of trolley for the transport of one football/handball goal



art. 6044 Contenitori per zavorra da applicare su porte da calcio mobili NON a norma UNI o sulle porte calcetto mobili. Zavorra esclusa

Storage for ballast to apply to NO UNI freestanding soccer goals or freestanding futsal goals



art. 6047 Sacco di appesantimento per zavorrare le porte, in pvc elettrosaldato, riempibile di acqua o sabbia, con tappo di chiusura.

Bag for ballast to apply to goals, made in pvc, filled in water or sand

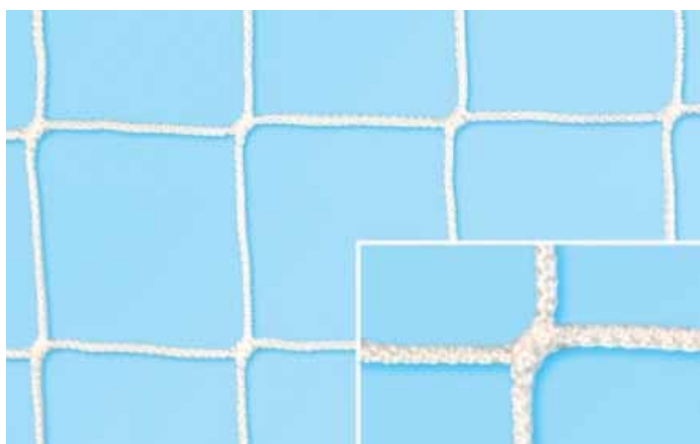

art. 7010 Reti in nylon pesanti \varnothing 3 mm, maglia 90 mm

Nets in heavy nylon, \varnothing 3 mm mesh 90 mm



art. 7011 Reti in nylon super pesanti \varnothing 6 mm

Nets in heavy nylon, \varnothing 6 mm



art. 7700 Impianto regolamentare in acciaio verniciato con zavorra mod. professionale
Freestanding competition badminton posts, mobile on wheels



- art. 7710** Rete regolamentare 6,10 mt
Regulation badminton net 6,10 mt
- art. 7715** Racchetta grafite/alluminio
Carbon/aluminium badminton racket
- art. 7716** Racchetta badminton acciaio/alluminio
Steel/aluminium badminton racket



art. 7908 Tavolo tennis per interno con ruote, sostegno e rete, mod. "Cornilleau 300"

Steel hurdles, fixed eight cm 12-14-16-18-20-22-24-26-28-30

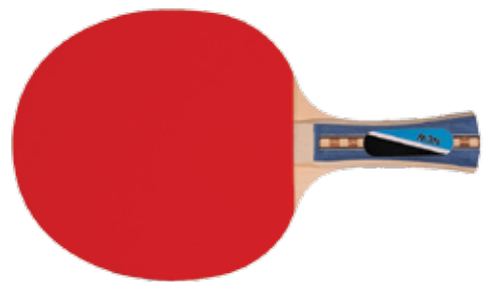

art. 7925 Racchetta liscia

Table tennis bat



art. 7905 Tavolo tennis per esterno con ruote, sostegno e rete, mod. "Superolimpic"

Outdoor tennis table foldable and movable, net included, mod. "Superolimpic"

art. 7901 Tavolo tennis per interno con ruote, sostegno e rete, mod. "Superolimpic"

Indoor tennis table foldable and movable, net included, mod. "Superolimpic"

ATLETICA

athletics



VIVISPORT



art. 3082 Ponte per fotofinisch 6-8 corsie

Photo finish deck 6/8 decks



art. 3036 Ostacolo in acciaio/alluminio

alt. cm 76,2-84-91,4-100-106,7 asse in pvc

*Olympic hurdle in steel/aluminium height
 cm 76,2-84-91,4-100-106,7 PVC board*



art. 3034 Ostacolo olimpionico acciaio/alluminio

alt. cm 76,2-84-91,4-100-106,7 I.A.A.F. da gara

*Olympic hurdle in steel/aluminium height c
 m 76,2-84-91,4-100-106,7 I.A.A.F. for race*



art. 3031 Ostacolo graduabile alt. cm 50-60-76,2
Hurdle graduated height cm 50-60-76,2



art. 3039 Ostacolo in acciaio alt. cm 76,2-84-91,4-100-106,7
asse in pvc
Hurdle in steel height cm 76,2-84-91,4-100-106,7 with
PVC board



art. 3032 Ostacolo graduabile alt. cm 76,2-84-91,4
Hurdle graduated height cm 76,2-84-91,4



art. 3041 Asticella in abs per ostacoli da gara
Abs crossbar for race hurdles



art. 3013 Ostacolo alluminio con staggio in abs, regolabile
cm 45/76,2
Aluminium hurdle with bar in abs, adjustable cm 45/76,2

art. 3014 Ostacolo alluminio con staggio in abs, regolabile
cm 76,2/106,7
Aluminium hurdle with bar in abs, adjustable cm 69/106,7



art. 3050 Carrello per trasporto ostacoli.
Hurdle transporter hold



art. 3005 Blocco di partenza a 3 ceppi uso anche palestra
Starting block with 3 block (gymnasium model)



art. 3008 Blocco di partenza mod. competition
blocchi alluminio
Starting block, aluminium blocks (competition model)



art. 3009 Blocco di partenza mod. olimpico da gara
Starting block (olympic race model)



art. 3010 Blocco di partenza mod. Super Olimpico omologato
I.A.A.F.
Starting block mod. Super Olympic, I.A.A.F. approved



art. 3012 Blocco partenza da gara in alluminio e ferro Polanik
omologato I.A.A.F.
*Starting block for competition, in aluminium and steel -
I.A.A.F. approved*



art. 3001 Testimone per staffetta in alluminio colorato a norma
I.A.A.F.
Relay baton in coloured aluminium, I.A.A.F. approved

art. 3002 Testimone per staffetta in pvc colorato
Relay baton in coloured PVC



art. 3210 Disco regolamentare omol. I.A.A.F. in nylon 1 Kg
Regulation discus, I.A.A.F. approved in nylon 1 Kg

art. 3213 Disco regolamentare omol. I.A.A.F. in nylon 2 Kg
Regulation discus, I.A.A.F. approved in nylon 2 Kg



art. 3285 Carrello porta dischi
Discus trolley

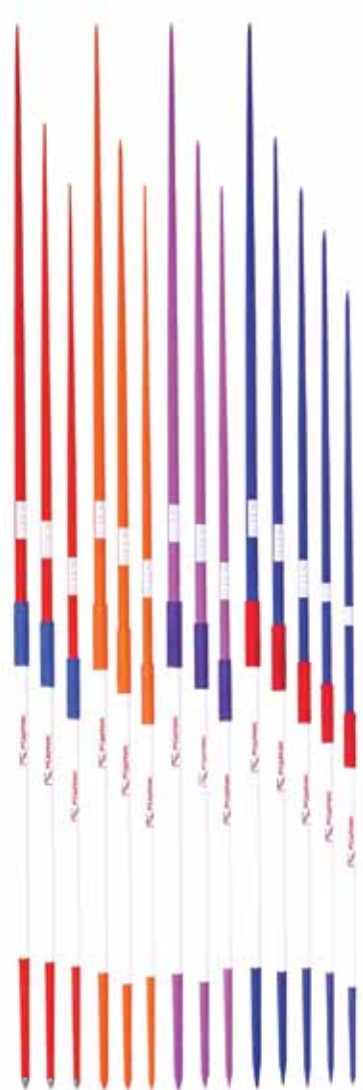

art. 3305 Giavelotto da competizione gara I.A.A.F. gr.400-500-600-700-800
Race competition javelin I.A.A.F. 400-600-700-800 gr.



art. 3307 Giavelotto VORTEX in gomma con coda alettata per int.ed est.
Javelin VORTEX in rubber with louvers tail for outdoor and indoor use



art. 3273 Rastrelliera con ruote porta giavelotti
Javelin rack with wells



art. 3410 Martello da competizione omologato I.A.A.F. 4 Kg
Competition hammer, approved I.A.A.F. 4 Kg



art. 3288 Rastrelliera porta martelli
Hammer rack



art. 3421 Gabbia per lancio martello, in alluminio, mobile, completa omol. I.A.A.F.
Net cage for hammer throwing, aluminium, mobile, complete, approved I.A.A.F.



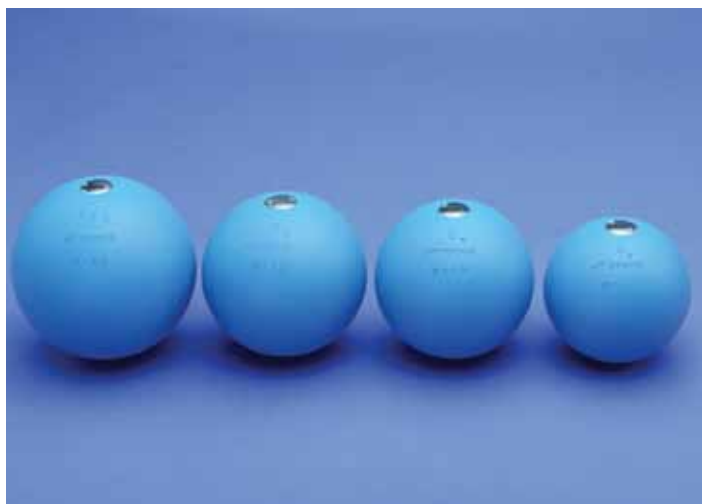

art. 3525 Palla getto da competizione
Competition shot



art. 3290 Rastrelliera con ruote porta pesi
Shot rack with wheels



art. 3532 Fermapiedi in legno nuova normativa
Wood feet block, new regulations



art. 3800 Asse di battuta per salto in lungo in legno, trattamento impregnante
Take off board per long jump in wood, impregnated treatment



art. 3602 Ritti salto alto zincati e verniciati basamento pesante a T alt. 2,5 mt
High jump stands steel, galvanized and painted, T heavy base, height 2,5 mt



art. 3610 Asticella in tubo di alluminio rotonda 4 mt
Round aluminium cross bar 4 mt

art. 3614 Asticella segnalimite in fibra di vetro rinforzato 4 mt
Crossbar in fiberglass reinforced 4 mt

art. 3613 Asticella segnalimite fibra vetro mod. UCS da gara 4 mt
Crossbar in fiberglass mod. UCS competition 4 mt



art. 3606 Ritti lega leggera da competizione a norme IAAF,
Competition light alloy high jump stands, in compliance with regulations I.A.A.F.

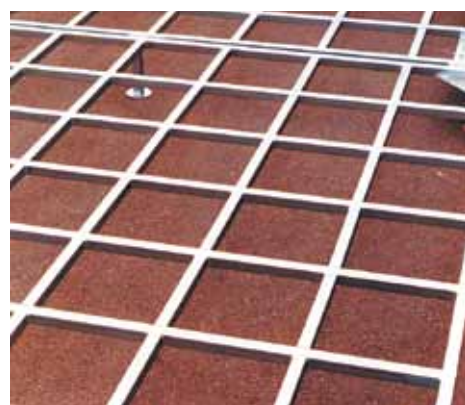

art. 3626 Area di caduta con rete e materassina, I.A.A.F.
600x400x70 cm
*High jump landing mat, I.A.A.F.
600x300x70 cm*

art. 3606 Ritti lega leggera da competizione a norme IAAF,
Competition light alloy high jump stands, in compliance with regulations I.A.A.F.

art. 3630 Piattaforma di sostegno zona caduta zincata a caldo con terminali gomma antiscivolo al mq
Galvanised platform for high jump landing areas per sm



art. 3701 Ritti asta gara Olympia grad. cm 300-640 omologati I.A.A.F.
Olympia pole vault stands cm 300-640 I.A.A.F. approved

art. 3733 Zona di caduta salto asta omologata I.A.A.F.
Pole vault landing area cm 660x730x181 I.A.A.F.

art. 3734 Rivestimento antipioggia per zona caduta salto con l'asta
Waterproof cover, pole area



art. 3085 Rotella metrica in acciaio da mt 20 con impugnatura
Steel measuring tapes mt 20 with handgrip

art. 3089 Rotella metrica in fiberglass da mt 50
Fiberglass measuring tapes mt 50

art. 3078 Pistola a tamburo cal. 38 per starter
Starting revolver bore 38

art. 3079 Cartucce per pistola starter 3078 conf. 50 pezzi
Blanks starter 3078 pack 50 pcs.

art. 3073 Megafono amplificato mod. Carol
Boosted megaphone, mod. Carol

art. 3001 Testimone per staffetta in alluminio colorato a norma I.A.A.F.
Relay baton in coloured aluminium, I.A.A.F. approved

art. 3002 Testimone per staffetta in pvc colorato
Relay baton in coloured PVC

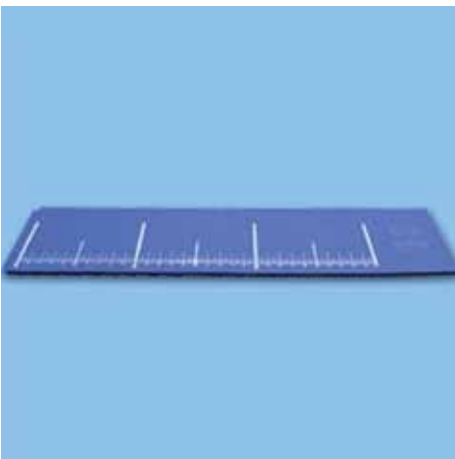

art. 5438 Mat test lungh. 370 cm larghezza 100 cm
Mat test lenght 370 cm width 100 cm



art. 3071 Cronometro digitale 100 memorie professionale
Digital chronometer 80 memories professional

art. 3070 Cronometro digitale 1/100 di secondo speed
Digital chronometer 1/100 of second speed

art. 3069 Cronometro digitale 1/100 di secondo sport
Digital chronometer 1/100 of second sport



art. 3049 Cronometro Hanhart preciso ad 1/100 di secondo con stampante
Chronometer Hanhart precise at 1/100 second with printer



art. 3081 Serie di 3 podi in legno bianchi da cm 60x60 alt. cm 10/15/20 numerati 1-2-3
Series of 3 white wood victory stands cm 60x60 height cm 10/15/20 numbered 1-2-3



art. 3270 Picchetto segnalanci numerato
Throwing marker stake, numbered in PVC, triangular

GINNASTICA

gymnastic



VIVISPORT



art. 1005 Castello per anelli da competizione completo
Castle for competition rings complete



art. 1154 Cavallo "olimpionico" omologato
Vaulting horse F.I.G. approved.



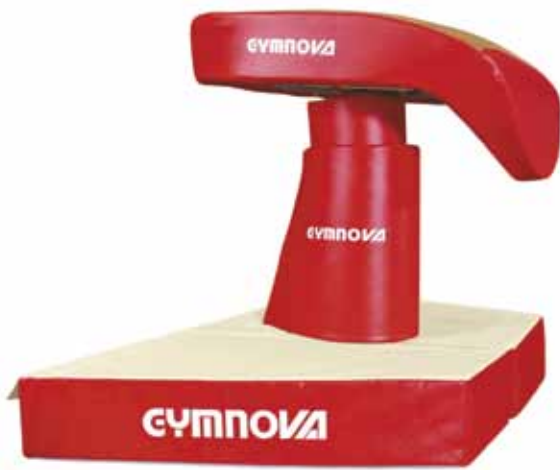

art. 1164 Piattaforma per volteggio cavallo omologata F.I.G.

Vaulting table, in accordance with regulation F.I.G.



art. 1157 Cavallo per volteggio riv. cuoio naturale, gambe monotubolari, ruote e fissaggio a terra

Vaulting horse, coverig in natural leather

Sistema di sicurezza

Security sistem



art. 1168 Cavallina rivestita in similpelle, ruote e fissaggio a terra

Vaulting buck, covering in synthetic leather, with transport wheels

Sistema di spostamento

Wheels for easy mobility

Appoggi antiscivolo

Non slip

Cricchetto per fissaggio a terra

Ground anchor system



art. 1553 Parallela femminile omologato
F.I.G.
*Women's parallel bar approved
F.I.G.*



art. 1552 Parallela maschile omologata
F.I.G.
Men's parallel bar approved F.I.G.

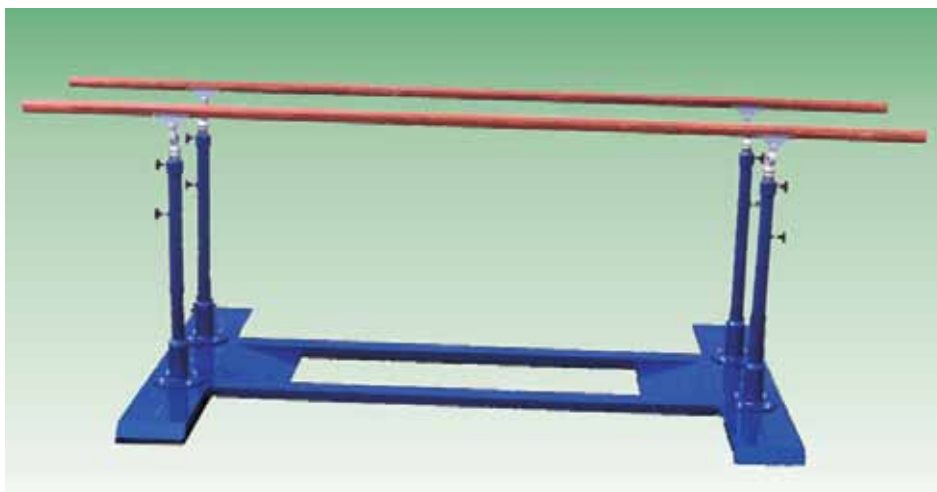

art. 1550 Parallela maschile olimpionica da competizione, staggi in legno regolamentari
Men's parallel bar for school, regulation bars in wood



art. 1551 Parallela femminile asimmetrica da competizione, staggi in legno regolamentari
Women's parallel bar asymmetric for school, regulation bars in wood

art. 1562 Carrello portaparallele
art. 1550-1551
*Parallel bars trolley
 item 1550-1551*



art. 1604 Plinto a cassoni norme UNI con sistema di trasporto incorporato
Vaulting box UNI approved with transport system built in



art. 1602 Plinto a cassoni in legno piano in cuoio
Vaulting box in wood, leather cover

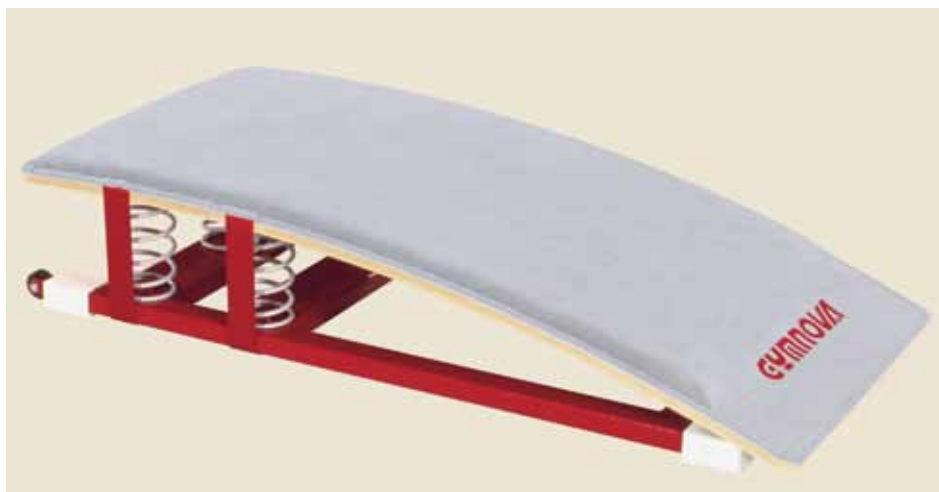

art. 1585 Pedana per corpo libero
omologata F.I.G.
*Springboard for free gymnastics
F.I.G. approved*

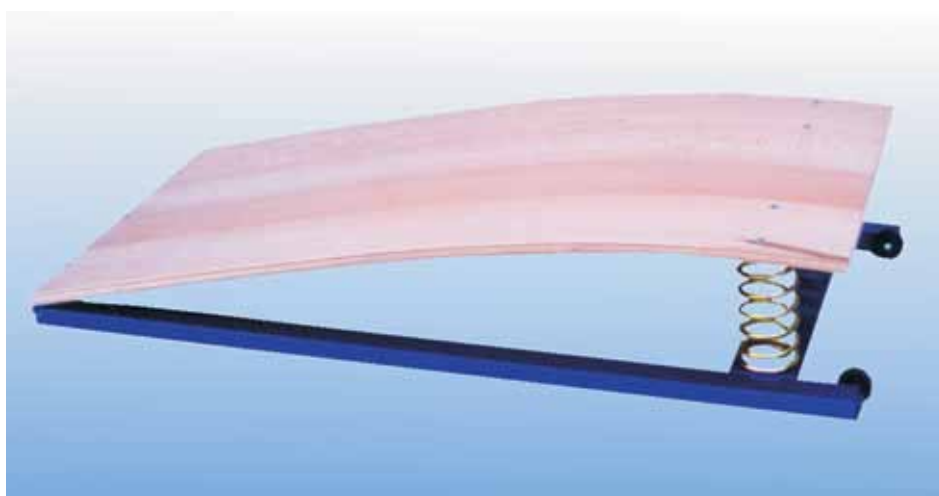

art. 1579 Pedana elastica con doppia
molla in acciaio
*Elastic springboard with double
steel spring*



art. 1583 Pedana elastica doppio
molleggio norme F.I.G.
*Elastic springboard double knee
bend F.I.G. regulations*



art. 1580 Pedana elastica tipo Reuther
piano verniciato
*Elastic springboard type Reuther
painted surface*



art. 1390 Palco di salita in acciaio verniciato e 2 funi in canapa 5 mt
Tower for climb, 2 poles in painted steel e 2 ropes 5 mt



art. 1428 Palco salita 3 pertiche
Tower for climb 3 poles



art. 1429 Palco salita 3 funi 5 mt
Tower for climb 3 ropes 5 mt



art. 1002 Anelli in legno con fune
Rings in wood with rope



art. 1170 Fune per palco salita con asola anello e terminale in pvc ø 28 mm-5 mt
Rope for tower for climb with ring buttonhole and end in pvc ø 28 mm-5 mt



art. 1420 Scala a corda con pioli in legno 5 mt
Rope ladder with rungs in wood 5 mt



art. 1691 Spalliera svedese a 2 campate 180xh250 cm
Swedish wall bar, 2 spans 180xh250 cm



art. 1515 Panchetta per addominali imbottita agganciabile a spalliera
Bench for abdominals, padded, to hang to wall bar

art. 1696 Poggiaschiena curvo imbottito per spalliera
Curved backrest, padded for wall bar

art. 1699 Spalliera svedese a 2 campate norme UNI 180xh250 cm
Swedish wall bar, 2 spans, norms UNI 180xh250 cm



art. 1681 Scala ortopedica diritta con montanti in acciaio mt 3
Orthopedic straight ladder with steel uprights mt 3



art. 1682 Scala ortopedica curva con montanti in legno
Orthopedic curved ladder with wood uprights



art. 1684 Scala orizzontale trasportabile 5 mt
Horizontal portable ladder 5 mt

art. 1683 Scala ortopedica diritta con montanti in legno
Orthopedic straight ladder with wood uprights



art. 1685 Scala orizzontale a parete 5 mt
Wall fixed horizontal ladder 5 mt



art. 1610 Quadro svedese in legno con attacchi acciaio, oscillante 16 fori
Swedish wall bar in wood with steel attachments, swinging 16 holes



art. 1611 Quadro svedese in legno con attacchi acciaio, oscillante 24 fori
Swedish wall bar in wood with steel attachments, swinging 24 holes



art. 1803 Trave di equilibrio femminile in alluminio omologata F.I.G. 5 mt
Women's balance beam in aluminium approved F.I.G. 5 mt



Terminale di sicurezza
Safety padding



art. 1802 Trave di equilibrio femminile alt. grad. 50-120 cm a norma F.I.G. 5 mt
Women's balance beam, height grad. 50-120 cm, norms F.I.G. 5 mt



art. 1801 Trave di equilibrio femminile alt. grad. 80-120 cm 5 mt
Women's balance beam, grad. Height 80-120 cm 5 mt



art. 1800 Trave di equilibrio femminile fissa altezza 50 cm 5 mt
Women's balance beam, fixed, height 50 cm 5 mt



art. 1031 Asse di equilibrio ad altezza graduabile 3 basi 5 ml
Balance axle, adjustable height, 3 bases 5 ml

art. 1030 Asse di equilibrio ad altezza fissa 3 basi 5 ml
Balance Axle, fixed height, 3 bases 5 ml



art. 1516 Panca svedese con asse equilibrio, telaio in ALLUMINIO 3 mt
Swedish bench in ALUMINIUM 3 mt



art. 1512 Panca svedese con asse struttura tubo \varnothing 40 mm, 3 mt
Swedish bench with beam structure tube \varnothing 40 mm, 3 mt



art. 1513 Panca svedese senza asse struttura tubo \varnothing 40 mm
Swedish bench without beam structure tube \varnothing 40 mm



art. 1517 Panchetta irrovesciabile tipo Pivetta imbottita
Bench that cannot be knocked over type Pivetta stuffed



art. 1518 Panca svedese completamente in legno con asse equilibrio 3 mt
Swedish wood bench with balance beam, 3 mt



art. 1519 Panca svedese a norme UNI con agganci per spalliera, 4 mt
Swedish bench approved UNI with hooks for wall bar, 4 mt



art. 1510 Panchetta per spalliera, struttura tubo \varnothing 40 mm, 60 cm
Wall bars bench, structure tube \varnothing 40 mm, 60 cm

art. 1511 Panchetta per spalliera, struttura tubo \varnothing 40 mm, 120 cm
Wall bars bench, structure tube \varnothing 40 mm, 120 cm



art. 1708 Trampolino elastico incl.e pegg.con imbottitura, 125x125 cm
Elastic springboard tilting and bending, with padding, 125x125 cm



art. 1709 Trampolino elastico fisso completo di imbottitura, 125x125 cm
Fixed elastic springboard complete with padding 125x125 cm



art. 1752 Mini trampolino altezza fissa, ø 97xh 25 cm
Mini springboard, fixed height ø 97xh 25 cm



- art. 1385** Nastro per ritmica / *Gymnastic ribbon*
- art. 1500** Palla ritmica gr 160 diam. 16 cm / *Gymnastic balls*
- art. 1081** Cerchio in PVC diam. 60 / *Gymnastic hoops in plastic*
- art. 1083** Cerchio in PVC diam. 70 / *Gymnastic hoops in plastic*
- art. 1085** Cerchio in PVC diam. 80 / *Gymnastic hoops in plastic*
- art. 1086** Cerchio in PVC diam. 90 / *Gymnastic hoops in plastic*
- art. 1060** Bastone legno cm 70 / *Gymnastic sticks*
- art. 1061** Bastone legno cm 80 / *Gymnastic sticks*
- art. 1062** Bastone legno cm 90 / *Gymnastic sticks*
- art. 1063** Bastone legno cm 100 / *Gymnastic sticks*
- art. 1064** Bastone legno cm 110 / *Gymnastic sticks*
- art. 1065** Bastone legno cm 120 / *Gymnastic sticks*
- art. 1020** Appoggi in legno verniciato / *Gymnastic supports in wood*
- art. 1104** Clavette in moplen gr 155 / *Gymnastic clubs plastic*
- art. 1021** Ceppo Baumann in legno / *Gymnastic log tipe in wood*
- art. 9593** Ceppo Baumann in legno colorato / *Gymnastic log tipe in printed wood*
- art. 1100** Clave in legno piccola / *Gymnastic club in wood small*
- art. 1101** Clave in legno media / *Gymnastic club in wood middle*
- art. 1102** Clave in legno grande / *Gymnastic club in wood big*



- art. 1461** Palla medica da 1 kg., diametro 12 cm., in gomma morbida con superficie ad alto grip, riempita di acqua. Produzione ITALIANA Colore = rosso
Medicine ball, 1 kg, diam. 12 cm., in rubber water filled, red color Made in Italy
- art. 1462** Palla medica da 2 kg., diametro 15 cm., in gomma morbida con superficie ad alto grip, riempita di acqua. Produzione ITALIANA Colore = giallo
Medicine ball, 2 kg, diam. 15 cm., in rubber water filled, yellow color Made in Italy

- art. 1463** Palla medica da 3 kg., diametro 17 cm., in gomma morbida con superficie ad alto grip, riempita di acqua. Produzione ITALIANA Colore = blu
Medicine ball, 3 kg, diam. 17 cm., in rubber water filled, blue color Made in Italy

- art. 1464** Palla medica da 4 kg., diametro 20 cm., in gomma morbida con superficie ad alto grip, riempita di acqua. Produzione ITALIANA Colore = rosa
Medicine ball, 4 kg, diam. 20 cm., in rubber water filled, purple color Made in Italy

- art. 1465** Palla medica da 5 kg., diametro 23 cm., in gomma morbida con superficie ad alto grip, riempita di acqua. Produzione ITALIANA Colore = arancio
Medicine ball, 5 kg, diam. 23 cm., in rubber water filled, orange color Made in Italy

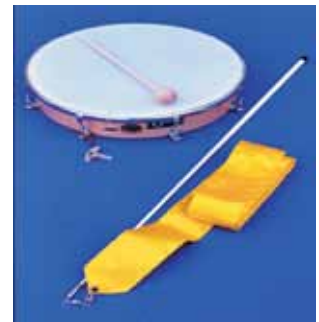

- art. 1387** Tamborello per ritmica ø 24 cm
Tamborello for rhythmic ø 24 cm
- art. 1385** Nastro per ritmica con astina a norma F.I.G. da 6 mt
Gymnastics ribbon with baton that complies with F.I.G. 6 mt



- art. 1022** Mensola a parete porta ceppi/appoggi/bastoni/funi e cerchi
Shelf block holder hoops, sticks, stumps, Ropes



art. 1380 Nastro per ritmica SASAKI in rayon, lunghezza 6 mt **OMOLOGATO FIG**
Gymnastics ribbon with baton IAAF approved



art. 1105 Clavetta SASAKI in plastica per competizioni, altezza 45 cm, **OMOLOGATO FIG**
Plastic rhythmic club, cm 45, IAAF approved



art. 1509 Palla ritmica SASAKI monocolore in caucciù naturale e verniciata con smalto speciale
Rhythmical ball IAAF approved



art. 1504 Palla ritmica ø cm. 17, 280 g.
Rhythmical ball ø cm 17, 280 gr



art. 1505 Palla ritmica ø cm. 18, 400 g., a norma FIG
Rhythmical ball ø cm 18, 400 gr approved F.I.G.



art. 1088 Cerchio SASAKI in materiale plastico ad altissima elasticità, sezione circolare, **OMOLOGATO FIG** ø 90 cm
Hoop, round F.I.G. approved ø 90 cm



art. 1377 Stuoia arrotolabile liscia in PE, 180x50x0,7 cm
Rolling up mat smooth in PE, 180x50x0,7 cm



art. 1386 Stuoia pieghevole in 5 sezioni, 180x50x0,7 cm
Mat in polyethylene foam in 5 sections, 180x50x0,7 cm



art. 1382 Stuoia ripiegabile in 4 sezioni, sfoderabile, con fodera in cotone 100%, 180x65x4 cm
Rolling up mat in 4 sections, with a removable cover 180x65x4 cm



art. 1364 Tatami judo pieghevole pleat-up mt 10x2 sp. 4 cm
Tatami judo foldable pleat-up mt 10x2 thickness 4 cm

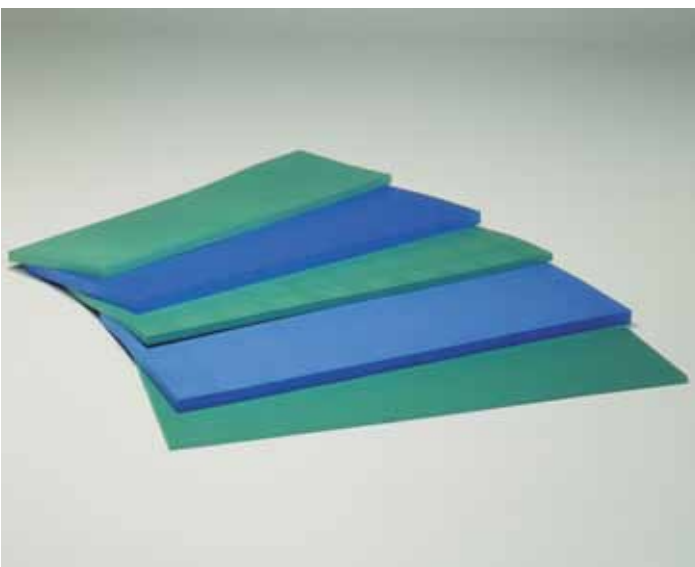

art. 1350 Tappeto MAT GOLD K14 fondo antiscivolo, 200x100x3 cm
Gym MAT GOLD K14 non-slip underside, 200x100x3 cm

art. 1351 Tappeto MAT GOLD K16 fondo antiscivolo, 200x100x4 cm
Gym MAT GOLD K16 non-slip underside, 200x100x4 cm

art. 1352 Tappeto MAT GOLD K20 fondo antiscivolo, 200x100x5 cm
Gym MAT GOLD K20 non-slip underside, 200x100x5 cm

art. 1353 Tappeto MAT GOLD K24 fondo antiscivolo, 200x100x6 cm
Gym MAT GOLD K24 non-slip underside, 200x100x6 cm



art. 1257 Materasso densità 16 fondo antiscivolo, 200x100x50 cm
Gymnastic mat density 16 non-slip underside, 200x100x50 cm



art. 1251 Materasso densità 16 fondo antiscivolo,
200x100x20 cm
*Gymnastic mat density 16 non-slip underside,
 200x100x20 cm*

art. 1203 Materasso rivestito in pvc fondo antiscivolo,
200x100x10 cm
*Gymnastic mat covered with pvc non-slip underside
 200x100x10 cm*



art. 1201 Materasso rivestito in pvc fondo antiscivolo,
200x100x5 cm
*Gymnastic mat covered with pvc with non-slip underside,
 200x100x5 cm*

art. 1290 Carrello trasporto materassi smontato, 200x100 cm
Dismantled mats transport trolley, 200x100 cm



art. 1282 Materasso densità 16 taglio 45° fondo antiscivolo, 200x400x40 cm
Gymnastic mat density 16 folded 45°, non-slip underside, 200x400x40 cm

art. 1289 Piattaforma di sostegno zona caduta chiudibile e trasportabile su ruote
Platform landing area folding and portable on castors sizes on request



art. 1160 Stuoia moquette accoppiata a gomma dinam.fdo antiscivolo mt12/14/15x2 spess.cm3,5

Physical exercise lane, surface in moquette, underside in anti-slip foam, 25 mm thick



art. 1369 Tabellone elettronico per judo
Electronic scoreboard for judo

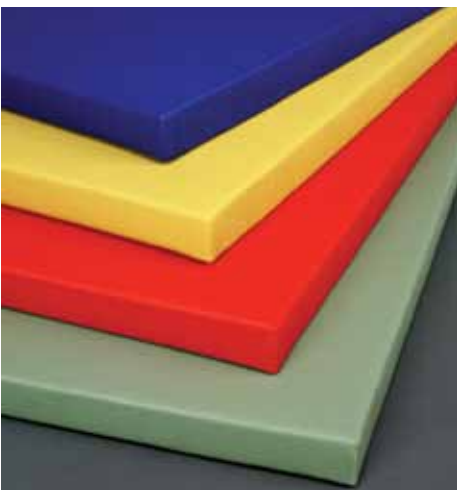

art. 1361 Tatami judo omologato I.J.F. densità 250 Kg/mc f.do antiscivolo, 200x100x4 cm
Tatami judo approved I.J.F. densità 250 Kg/cm non-slip underside, 200x100x4 cm



art. 1572 Mensola a parete fissa

Wall mounted steel support for ballet bar, fixed height



art. 1573 Mensola a parete regolabile in altezza

Wall mounted steel support for ballet bar, height adjustable



art. 1571 Sbarra per danza in legno ø 45 mm lunghezza superiore a 4 metri

Wooden ballet bar, diam. 45 mm length over 4 mt

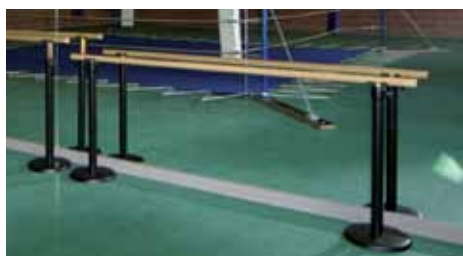

art. 1574 Supporto a terra regolabile in altezza

Steel support for ballet bar, to the floor, height adjustable



art. 1576 Sbarra per danza in legno ø 45 mm. lunghezza 2 metri

Wooden ballet bar, diam. 45 mm length 2 mt.



art. 1700 Specchio antinfortunistico modulare liscio, 100xh170 cm

Tempered glass plain mirror, to be fixed to the wall, 100xh170 cm



art. 1701 Specchio antinfortunistico quadrettato, 100xh170 cm

Tempered glass mirror with print-on pattern, to be fixed to the wall, 100xh170 cm



art. 1595 Supporto a terra regolabile in altezza con base maggiorata ancorabile a terra

Floor support height adjustable, heavy base made in galvanized steel fixable in the floor

art. 1702 Carrello per trasporto specchi modulari

Trolley for modular mirrors



art. 1048 Armadio in rete verniciato con maniglioni e ruote, 200x70x150 cm
Equipments and balls rack, with 2 folding doors and 4 wheels



art. 1052 Carrello portattrezzi su ruote in rete verniciato con 4 supporti
Equipments trolley in steel wire, painted. N° 4 equipment shelf included



art. 6811 Coppia carrelli per il trasporto di una porta calcetto/pallamano
Pair of trolley for the transport of one football/handball goal



art. 1044 Contenitore portapalloni in rete verniciata smontabile, 100x75x90 cm
Equipments and balls trolleys in steel wire, painted, detachable, 100x75x90 cm



art. 1043 Contenitore portapalloni in rete verniciato, 73x73x73 cm
Equipments and balls trolleys in steel wire, painted, 73x73x73 cm



art. 1037 Contenitore portapalloni in rete verniciato smontabile, 70x70x70 cm
Equipments and balls trolleys in steel wire, painted, detachable, 70x70x70 cm



art. 1042 Armadio porta attrezzi con 4 ripiani, 200x100x45 cm
Equipment locker, steel, 4 shelves, 2 shutters, 200x100x45 cm



AEROBICA

body building



VIVISPORT



art. 2001 Aerobic step in poliuretano stampato, 90x40xh20 cm
Aerobic step in printed polyurethane, 90x40xh20 cm



art. 2002 Aerobic step in plastica, altezza regolabile, 66x29 cm
Aerobic step in plastic, adjustable height, 66x29 cm



art. 2056 Cintura con elastico lungo 3 metri per corsa trattenuta
Belt for traction, boa model, high resistance made in elastic tube, 3 mt long



art. 2120 Rastrelliera porta manubri, tipo espositore
Dumbbells vertical rack, tipo exhibitor



art. 2099 Manubrio in ghisa rivestito in vinile colorato, 0,50 Kg/cad. al paio
Fitness iron dumbbells, covered with coloured vinyl, 0,50 Kg/each per pair

art. 2100 Manubrio in ghisa rivestito in vinile colorato, 1 Kg/cad. al paio
Fitness iron dumbbells, covered with coloured vinyl, 1 Kg/each per pair

art. 2101 Manubrio in ghisa rivestito in vinile colorato, 2 Kg/cad. al paio
Fitness iron dumbbells, covered with coloured vinyl, 2 Kg/each per pair



art. 2004 Banda elastica per aerobica blu, molto resistente, sp. 0,35 h 15 lungh. mt 25

Elastic strip for aerobics blue, very strong, thick. 0,35 h 15 length mt 25

art. 20041 Banda elastica per aerobica gialla, poco resistente, sp. 0,35 h 15 lungh. mt 25

Elastic strip for aerobics yellow, not very strong, thick. 0,35 h 15 length mt 25

art. 20042 Banda elastica per aerobica rossa, medio resistente, sp. 0,35 h 15 lungh. mt 25

Elastic strip for aerobics red, strong enough, thick. 0,35 h 15 length mt 25

art. 20043 Banda elastica per aerobica verde, resistente, sp. 0,35 h 15 lungh. mt 25

Elastic strip for aerobics green, strong, thick. 0,35 h 15 length mt 25



art. 2011 Elastico tubing rosso con maniglie

Red elastic tubing, with handles

art. 2009 Elastico tubing giallo con maniglie

Yellow elastic tubing, with handles

art. 2010 Elastico tubing blu con maniglie

Blue elastic tubing, with handles



art. 2062 Polsiera a fascia, (al paio 1 Kg), al paio
Wrist band, (per pair 1 Kg), per pair

art. 2063 Polsiera a fascia, (al paio 2 Kg), al paio
Wrist band, (per pair 2 Kg), per pair

art. 2064 Polsiera a fascia, (al paio 3 Kg), al paio
Wrist band, (per pair 3 Kg), per pair

art. 2065 Polsiera a fascia, (al paio 4 Kg), al paio
Wrist band, (per pair 4 Kg), per pair

art. 2066 Polsiera a fascia, (al paio 5 Kg), al paio
Wrist band, (per pair 5 Kg), per pair



art. 2032 Barra zavorrata Fit-bar da 80 cm Kg 3,6
Ballasted bar Fit-bar 80 cm Kg 3,6

art. 2033 Barra zavorrata Fit-bar da 100 cm Kg 4,5
Ballasted bar Fit-bar 100 cm Kg 4,5

art. 2034 Barra zavorrata Fit-bar da 120 cm Kg 5,4
Ballasted bar Fit-bar 120 cm Kg 5,4

art. 2035 Barra zavorrata Fit-bar da 140 cm Kg 6,3
Ballasted bar Fit-bar 140 cm Kg 6,3

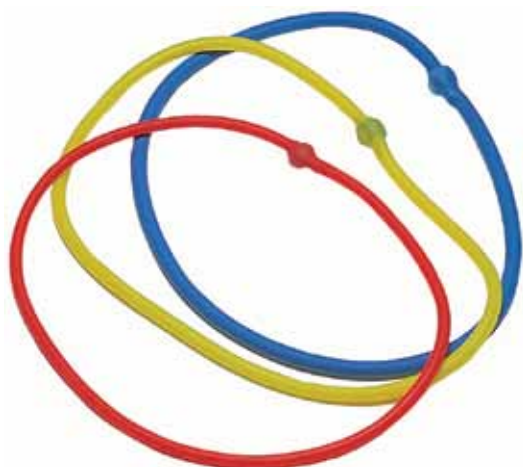

art. 2013 **Elastico tubing rosso ad anello, poco resistente**

Red ring elastic tubing, not very strong

art. 2014 **Elastico tubing giallo ad anello, medio resistente**

Yellow ring elastic tubing, strong enough

art. 2015 **Elastico tubing blu ad anello, molto resistente**

Blue ring elastic tubing, very strong



art. 2046 **Elastico a banda regolabile mm 25 con maniglie**

Adjustable strip elastic mm 25 with handles



art. 2017 **Elastico ad anello, mm 25 regolabile, per aerobica**

Ring elastic, mm 25 adjustable, for aerobics



art. 2071 **Bilanciere ø mm 25 con fermadischi, lungh. 150 cm**

Barbell ø mm 25 with discs stopper, length 150 cm

art. 2072 **Bilanciere ø mm 25 con fermadischi, lungh. 180 cm**

Barbell ø mm 25 with discs stopper, length 180 cm



art. 2096 **Rastrelliera portadischi verniciata**

Painted vertical discs rack



art. 2053 **Cintura zavorrata a pesi estraibili-peso variabile gr. 150 a cilindro, 5 Kg**

Ballasted belt with extractable weights- varying weight gr. 150 per roll



art. 2300 Elastico Stroops viola con maniglie, resistenza molto leggera. Lung. 120 cm

Slastix toner with protective sleeve, very light resistance - purple. Length 120 cm



art. 2302 Elastico Stroops giallo con maniglie, resistenza leggera. Lung. 120 cm

Slastix toner with protective sleeve, light resistance - yellow. Length 120 cm



art. 2310 Elastico Stroops argento con maniglie, resistenza extra forte. Lung. 120 cm

Slastix toner with protective sleeve, super high resistance - silver. Length 120 cm

art. 2301 Elastico Stroops viola con maniglie, resistenza leggera. Lung. 180 cm

Slastix toner with protective sleeve, very light resistance - purple. Length 180 cm

art. 2303 Elastico Stroops giallo con maniglie, resistenza leggera. Lung. 180 cm

Slastix toner with protective sleeve, light resistance - yellow. Length 180 cm

art. 2311 Elastico Stroops argento con maniglie, resistenza extra forte. Lung. 180 cm

Slastix toner with protective sleeve, super high resistance - silver. Length 180 cm



art. 2320 Elastico Stroops viola con maniglie, ideale per pedana Bosu e step. Lung. 215 cm resistenza molto leggera

Slastix toner for Bosu with protective sleeve and strap, very light. Length 215 cm resistance - purple



art. 2321 Elastico Stroops giallo con maniglie, ideale per pedana Bosu e step. Lung. 215 cm resistenza leggera

Slastix toner for Bosu with protective sleeve and strap, light. Length 215 cm resistance - yellow



art. 2322 Elastico Stroops rosso con maniglie, ideale per pedana Bosu e step. Lung. 215 cm resistenza media

Slastix toner for Bosu with protective sleeve and strap, medium. Length 215 cm resistance - red



art. 2304 **Elastico Stroops rosso con maniglie, resistenza media. Lung. 120 cm**

Slastix toner with protective sleeve, medium resistance - red. Length 120 cm



art. 2306 **Elastico Stroops blu con maniglie, resistenza forte. Lung. 120 cm**

Slastix toner with protective sleeve, heavy resistance - blue. Length 120 cm



art. 2308 **Elastico Stroops verde con maniglie, resistenza molto forte. Lung. 120 cm**

Slastix toner with protective sleeve, very high resistance - green. Length 120 cm

art. 2305 **Elastico Stroops rosso con maniglie, resistenza media. Lung. 180 cm**

Slastix toner with protective sleeve, medium resistance - red. Length 180 cm

art. 2307 **Elastico Stroops blu con maniglie, resistenza forte. Lung. 180 cm**

Slastix toner with protective sleeve, heavy resistance - blue. Length 180 cm

art. 2309 **Elastico Stroops verde con maniglie, resistenza molto forte. Lung. 180 cm**

Slastix toner with protective sleeve, very high resistance - green. Length 180 cm



art. 2323 **Elastico Stroops blu con maniglie, ideale per pedana Bosu e step. Lung. 215 cm resistenza forte**

Slastix toner for Bosu with protective sleeve and strap, heavy. Length 215 cm resistance - blue



art. 2324 **Elastico Stroops verde con maniglie, ideale per pedana Bosu e step. Lung. 215 cm resistenza molto forte**

Slastix toner for Bosu with protective sleeve and strap, very high. Length 215 cm resistance - green



art. 2315 **Fit Stick Stroops, barra per elastici con maniglie (elastici esclusi)**

Stroops Fit-Stik, breaking apart fitness bar which can fit any handle of the toners through the screw ending caps



art. 2041 Semisfera equilibrio a rigidità ed elasticità variabile con elastici

Balance half sphere, varying rigidity and elasticity, with elastic band

art. 9301 Tavoletta propiocettiva rotonda in legno verniciato ø 60 cm

Round painted wood little plate ø 60 cm

art. 9303 Tavoletta rettangolare in legno con traversino 60x40 cm

Rectangular wood little plate with cross bar 60x40 cm

art. 9305 Tavoletta rettangolare in legno con semilune 60x40 cm

Rectangular wood little plate with half semilune 60x40 cm



art. 2048 Semisfera BOSU balance trainer pro

Balance half sphere BOSU

art. 9308 Tavoletta propiocettiva rotonda in legno con semisfera gonfiabile

Round painted wood little plate, with inflatable half sphere



art. 2040 Piano galleggiante a resistenza regolabile

Floating board, adjustable resistance

art. 2043 Piano galleggiante e rotante a resistenza regolabile

Afloat and rotating plan to varying resistance



art. 9322 Disco propriocettivo in gomma gonfiabile. ø 39 cm
Disk proprioceptor inflatable. ø 39 cm



art. 2042 Tavoletta in legno unita ad una palla ellittica gonfiabile
Wood board with pumping elliptical sphere



art. 2038 Palla con maniglia a peso variabile da 0,9 Kg a 3 Kg riempibile
Ball with handle, refillable



art. 2201 Cerchio per pilates ø 38 cm
Circles for pilates ø 38 cm



art. 2022 Softgym Overball ø max 26 cm
Softgym Overball ø max 26 cm



art. 2023 Fitball Roller lungo 75 cm, ø max 18 cm
Fitball Roller length 75 cm, ø max 18 cm



art. 2024 Base per barrel 75x45x15x25h. Max
Base per barrel 75x45x15x25h. Max

art. 2026 Semicilindro medio per barrel 45x45x15 cm
Half roll, medium for barrel 45x45x15 cm



art. 2025 Semicilindro piccolo per barrel 45x45x10 cm
Half roll, small for barrel 45x45x10 cm

art. 2027 Semicilindro grande per barrel 45x45x20 cm
Half roll, big for barrel 45x45x20 cm



art. 2050 Cintura in cuoio per sollevamento pesi
Leather belt to lift weights

art. 1564 Magnesio in pani 50 gr 1 pane
Magnesia blocks 50 gr 1 block

art. 2051 Guanti in cotone e pelle al paio
Gymnastic gloves



art. 2154 Bike spinning
Bike spinning



art. 2152 Cyclette accessoriata di computer magnetica modello "Professional 1400"
Magnetic cyclette with computer model "Professional 1400"



art. 2170 Panca schienale e sedile regolabile multifunzioni
Bench with wall bar and seat adjustable, multi functions



art. 2178 Stazione multifunzione richiudibile
Folding multifunctional bench



art. 2181 Panca regolabile con porta bilanciere
Adjustable bench with support for barbell



art. 2172 Stazione multifunzione
Folding multifunctional



art. 2174 Panca inversione per stretching
Inversion flex gravity for stretching



art. 2143 Panca triplo uso
Curved bench triple use



art. 2156 Bike ellittica modello 3300
Elliptical bike model 3300



art. 2157 Bike ellittica modello 3400
Professional elliptical bike model 3400



art. 2158 Bike ellittica modello 3600
Professional elliptical bike model 3600



art. 2160 Pedana jogging - 16 km/h - 2,0/3,0 hp - incl. elettrica - corsia 400x1200 mm
Treadmill - 16 km/h - 2,0/3,0 hp - lane 400x1200 mm



art. 2161 Pedana jogging - 20 km/h - 3,0/5,0 hp - incl. elettrica - corsia 500x1480 mm - fascia cardio - MP3
Treadmill - 20 km/h - 3,0/5,0 hp - lane 500x1480 mm - cardio belt - MP3



art. 2163 Pedana jogging - 20 km/h - 3,0/4,5 hp - incl. elettrica - corsia 500x1400 mm
Treadmill - 20 km/h - 3,0/4,5 hp - lane 500x1400 mm



art. 2164 Pedana jogging - 20 km/h - 3,0/4,5 hp - incl. elettrica - corsia 500x1400 mm - fascia cardio
Treadmill - 20 km/h - 3,0/4,5 hp - lane 500x1400 mm - cardio belt



art. 2122 Leg press
Leg press



art. 2129 Multy power prof
Multy power prof



art. 2121 Leg extension machine
Leg extension machine



art. 2133 Pek dek multiuso
Pek dek multipurpose



art. 2136 Glutes machine
Gluteus machine



art. 2132 Pulley machine
Pulley machine



art. 2125 Lat machine
Lat machine



art. 2140 Leg curling machine
Leg curling machine



art. 2124 Pectoral machine
Pectoral machine

PRIMA INFANZIA

gym equipment for kids





art. 9710-9711-9712-9713-9714-9715-9716

Giochi componibili materiale plastico robusto, atossico, resistente ai raggi
Outdoor Gym equipment for kids.



Composizione da ginnastica per bimbi

Gym equipment for kids, ideal for climbing, crawling, jumping, rolling



art. 9333 Paracadute in nylon mt 3 per psicomotricità

Psychomotor parachute in nylon mt 3



art. 9606 Pannello per arampicata completo di prese agganciabile alla spalliera

Climbing panel complete with grip, wall bars attachable

art. 9607 Pannello per arampicata completo di prese agganciabile al muro

Climbing panel complete with grip, wall attachable

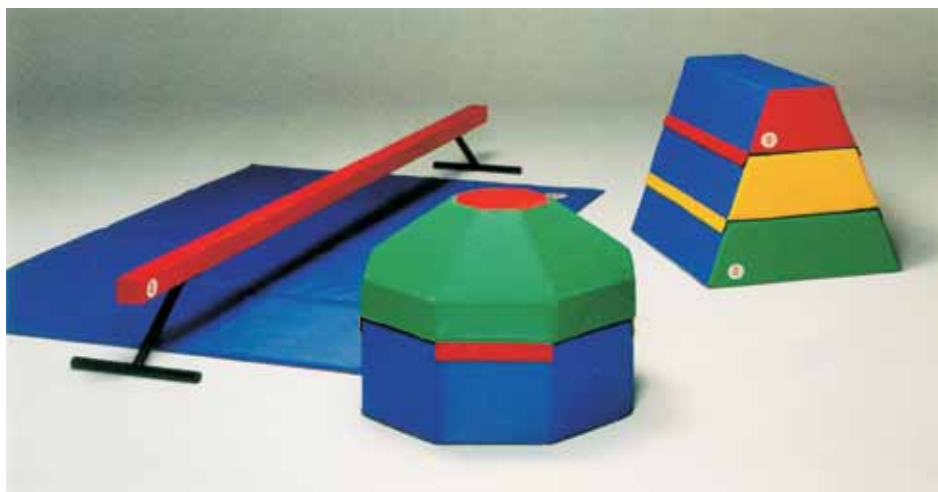

art. 9521 Plinto a base rettangolare

Trapezoid-vaulting box

art. 9522 Fungo a base ottagonale

Mushroom mat.

art. 1379 Stuoia pieghevole
cm 400x200x20

Folding mats usable as platform



art. 9555 Grande area pieghevole
sp. cm 4 con antiscivolo

*Folding big area thickness
cm 4 with nonslip*



art. 9518 Piscina grande diametro
cm 190 sp. cm 15 alt. cm 60

*Big ballpool, diameter cm 190
thickness cm 15 height cm 60*

art. 9520 Pallina per piscina unico colore
ø 70 mm 700 pezzi

*Pool ball, single colour ø 70 mm
700 pcs.*



art. 9401 Triangolo 30x40 cm

Triangle ludiblock 30x40 cm

art. 9402 Cubo 30x30x30 cm

Cube ludiblock 30x30x30 cm

art. 9403 Parallelepipedo 30x60x15 cm

Parallelepiped ludiblock 30x60x15 cm

art. 9404 Cilindro 100x25 cm

Cylinder ludiblock 100x25 cm

art. 9405 Semicilindro 50x25 cm

Half cylinder ludiblock 50x25 cm

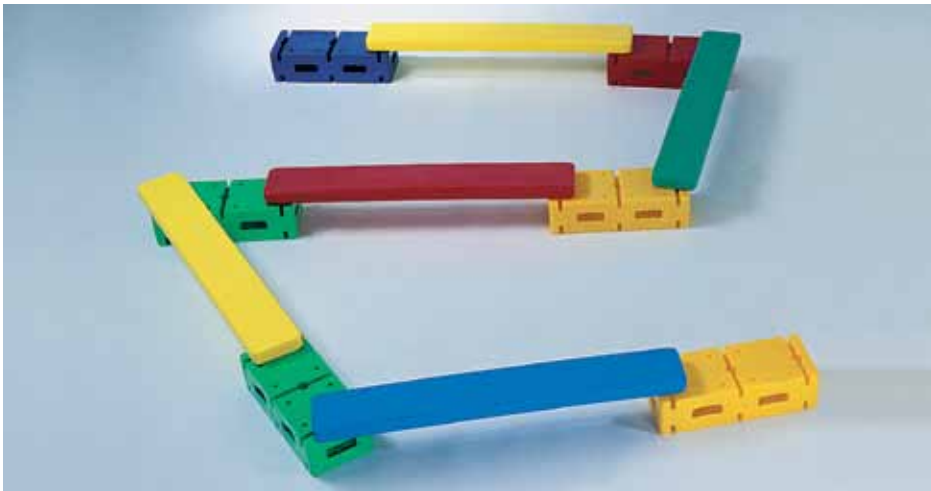

art. 9446 Percorso equilibrio plastica
composto da 5 assi plastica, 6
mattoni percorso, 24 ventose
*Balance plastic course,
composed of 5 plastic boards, 6
course blocks, 24 suckers*



art. 9433 Clip rotante
aggancio asta/asta
*Pole pole rotatine
clip*



art. 9434 Clip rotante
aggancio asta/
cerchio piatto
nylon
*Pole flat hoop
rotatine-clip in nylon*



art. 9435 Clip rotante
aggancio asta/
cerchio o tondo pvc
*Pole tubular hoop
rotative-clip pvc*



art. 9438 Clip supporto
Clip support

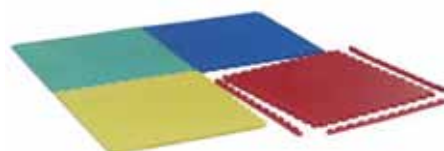
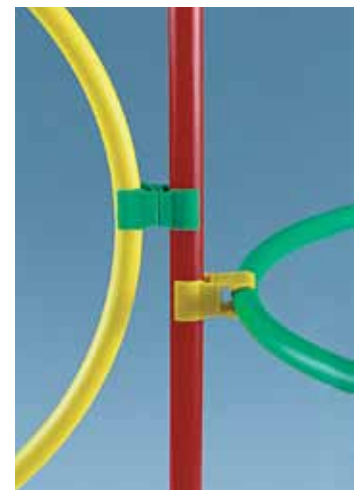

art. 9551 Pavimentazione ad incastro.
Colore rosso cm 100x100x2
*Joint flooring cm 100x100x2.
Red*



art. 9556 Pavimentazione antitrauma
ad incastro con erba sintetica
cm 96x96x3
*Joint flooring with synthetic
grass cm 96x96x3*

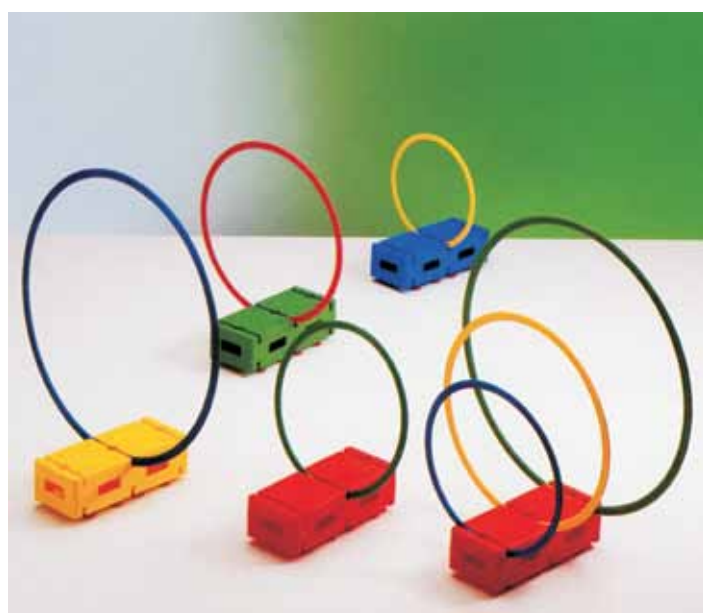

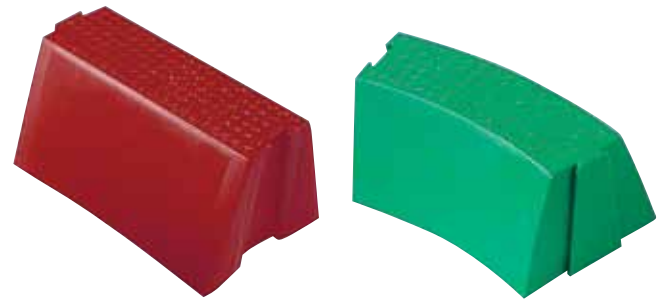

art. 9452 Confezione da n° 10 mattoni percorso dritto
Pack of no. 10 straight course block

art. 9453 Confezione da n° 10 mattoni percorso curvo
Pack of no. 10 curved course block



art. 1752 Mini trampolino altezza fissa ø 97 x h 25 cm
Mini springboard, fixed height ø 97 x h 25 cm



art. 9390 Brandina impilabile
Kid's bed



art. 9310-9311-9312-9313-9314-9315-9316
Maxipallone psicomotorio ø 45-55-6575-85-95-120 cm
Big soft ball ø 45-55-6575-85-95-120 cm



art. 9330 Set psicomotorio escluso carrello
Psychomotorial set, trolley excluded

art. 9331 Carrello psicomotorio in legno con ruote
Psychomotorial, trolley with castors

TABELLONI ELETTRONICI

scoreboards



VIVISPORT



art. 8404 Tabellone elettronico multisport per grandi palestre
150x98x7 cm

*Electronic multisport scoreboard, digits 20 cm high
150x98x7 cm*



art. 8475 Tabellone multisport con segnalazione del tempo di gioco, punteggio 200x180x9 cm (da 0 a 99), periodo (da 0 a 9), bonus (1 punto luminoso per squadra), time-out (3 punti lum. per squadra), possesso/servizio/turno (freccia), falli di squadra/set vinti (da 0 a 9), ultimo fallo avvenuto (n° maglia giocatore da 0 a 99 e numero del fallo da 0 a 9) con nome squadra programmabile

Multisport scoreboards displaying game time, team scores (0-99), 200x180x9 cm period (0-9), bonus (1 light indicator per team), time-out (3 light indicators per team), possession/Service/Turn (arrow), team fouls/sets won (0-9), last foul: (0-99) player number - (0-9) foul number team name programmable



art. 8390 Tabellone multisport portatile da tavolo. basket/pallavolo/calcetto/pallamano/pallanuoto/ping pong/kick-boxing 55x35x9,5 cm

Electronic multisport scoreboard portable basket/volleyball/soccer to five/handball/water polo/ping pong/kick-boxing 55x35x9,5 cm



art. 8442 Tabellone Pulsar punteggio, set, bonus, cronometro cifre alt. 17,4 75x59x10 cm

Pulsar Scoreboard: score, set, bonus, possession. Digits 17,4 cm high 75x59x10 cm



art. 8441 Tabellone Pulsar punteggio, set, bonus, possesso cifre alt. 17,4, 85x38x11 cm

Pulsar Scoreboard: score, set, bonus, possession. Digits 17,4 cm high 85x38x11 cm



art. 8473 Come art. 8472 ma con nome squadra programmabile (8 caratteri per squadra)

Like 8472 but with the team name programmable



art. 8474 Tabellone multisport con segnalazione del tempo di gioco, punteggio 200x180x9 cm (da 0 a 199), periodo (da 0 a 9), bonus (1 punto luminoso per squadra), time-out (3 punti lum. per squadra), possesso/servizio/turno (freccia), falli di squadra/set vinti (da 0 a 9), ultimo fallo avvenuto (n° maglia giocatore da 0 a 99 e numero del fallo da 0 a 9)

Multisport scoreboards displaying game time, team scores (0-199), 200x180x9 cm period (0-9), bonus (1 light indicator per team), time-out (3 light indicators per team), possession/Service/Turn (arrow), team fouls/sets won (0-9), last foul: (0-99) player number - (0-9) foul number



art. 8449 Tabellone Pulsar punteggio, set, bonus, possesso cifre alt. 17,4, 85x38x11 cm

Pulsar Scoreboard: score, set, bonus, possession. Digits 17,4 cm high 85x38x11 cm



art. 8444 Come il tabellone art. 8441 ma con telecomando infrarossi 85x38x11 cm
Scoreboard item 8441 with remote control 85x38x11 cm



art. 8445 Come il tabellone art. 8442 ma con telecomando infrarossi 75x59x10 cm
Scoreboard item 8442 with remote control 75x59x10 cm



art. 8453 Tabellone Pulsar punteggio, set, bonus, falli, cronometro cifre alt. 17,4, 75x59x10 cm ideale per calcetto
Pulsar Scoreboard score, set, bonus, chronometer, fault. Digits 17,4 cm high for soccer to 5, 75x59x10 cm



art. 8471 Come art. 8470 ma con nome squadra programmabile (8 caratteri per squadra)
Like 8470 but with the team name programmable



art. 8470 Tabellone multisport con segnalazione del tempo di gioco, punteggio 200x120x9 cm (da 0 a 199), periodo (da 0 a 9), bonus (1 punto luminoso per squadra), time-out (3 punti lum. per squadra), possesso/servizio/turno (freccia).
Multisport scoreboards displaying game time, team scores (0-199), 200x120x9 cm period (0-9), bonus (1 light indicator per team), time-out (3 light indicators per team), possession/Service/Turn (arrow)



art. 8472 Tabellone multisport con segnalazione del tempo di gioco, punteggio 200x180x9 cm (da 0 a 199), periodo (da 0 a 9), bonus (1 punto luminoso per squadra), time-out (3 punti lum. per squadra), possesso/servizio/turno (freccia), falli di squadra/set vinti (da 0 a 9)
Multisport scoreboards displaying game time, team scores (0-199), 200x180x9 cm period (0-9), bonus (1 light indicator per team), time-out (3 light indicators per team), possession/Service/Turn (arrow), team fouls/sets won (0 a 9)



art. 8490 Coppia pannelli laterali per 12 giocatori ogni squadra con la visualizzazione dei numeri di maglia (da 4 a 15 fissi non modificabili) e dei falli/penalità (4 punti luminosi + 1 rosso) 120x260x11,5 cm

Pair of statistics panels (side displays) for 12 player per team showing the player number (from 4 to 15, fixed, can not be changed) and fouls/penalties (4 indicator lights + 1 red) 120x260x11,5 cm



art. 8492 Coppia pannelli laterali per 12 giocatori ogni squadra con la visualizzazione dei numeri di maglia (da 0 a 99 programmabili), dei falli/penalità (4 punti luminosi + 1 rosso) e dei punti personali (da 0 a 99) 120x260x11,5 cm

Pair of statistics panels (side displays) for 12 player per team showing the player number (from 0 to 99 programmable), fouls/penalties (4 indicator lights + 1 red) and personal score (from 0 to 99) 120x260x11,5 cm



art. 8499 Coppia pannelli laterali per 14 giocatori ogni squadra con la visualizzazione dei numeri di maglia (da 0 a 99 programmabili), dei falli/penalità (da 0 a 9) e dei punti personali (da 0 a 99) 80x300x11,5 cm

Pair of statistics panels (side displays) for 14 player per team showing the player number (from 0 to 99 programmable), fouls/penalties (from 0 to 9) and personal score (from 0 to 99) 80x300x11,5 cm



art. 8460 Tabellone elettronico per esterno con visualizzazione per punteggio (da 0 a 9) e del tempo di gioco. Ogni cifra è alta 45 cm ed è composta da 264 led ad alta visibilità. Quando la console è spenta o scollegata viene visualizzata automaticamente l'ora del giorno. Resistente agli urti, a norma DIN 18032-3 e UNI 9554, 314,5x59x15 cm

Outdoor scoreboard displaying game time and team scores (0-9). Each 45cm digit is composed of 264 SMD LEDs. The time of day is automatically displayed when the console is turned off or disconnected. Impact resistant. Complies with DIN 18032-3 and UNI 9554 standards 314,5x59x15 cm



art. 8461 Tabellone elettronico per esterno con visualizzazione per punteggio (da 0 a 9) e del tempo di gioco. Ogni cifra è alta 45 cm ed è composta da 264 led ad alta visibilità. Quando la console è spenta o scollegata viene visualizzata automaticamente l'ora del giorno. Resistente agli urti, a norma DIN 18032-3 e UNI 9554, 166,5x118x15 cm

Outdoor scoreboard displaying game time and team scores (0-9). Each 45cm digit is composed of 264 SMD LEDs. The time of day is automatically displayed when the console is turned off or disconnected. Impact resistant. Complies with DIN 18032-3 and UNI 9554 standards 166,5x118x15 cm



art. 8462 Tabellone elettronico per esterno con visualizzazione per punteggio (da 0 a 99) e del tempo di gioco. Ogni cifra è alta 45 cm ed è composta da 264 led ad alta visibilità. Quando la console è spenta o scollegata viene visualizzata automaticamente l'ora del giorno. Resistente agli urti, a norma DIN 18032-3 e UNI 9554, 388,5x59x15 cm

Outdoor scoreboard displaying game time and team scores (0-99). Each 45cm digit is composed of 264 SMD LEDs. The time of day is automatically displayed when the console is turned off or disconnected. Impact resistant. Complies with DIN 18032-3 and UNI 9554 standards 388,5x59x15 cm



art. 8463 Tabellone elettronico per esterno con visualizzazione per punteggio (da 0 a 99), e del periodo/set (da 0 a 9) e del tempo di gioco. Ogni cifra è alta 45 cm ed è composta da 264 led ad alta visibilità. Quando la console è spenta o scollegata viene visualizzata automaticamente l'ora del giorno. Resistente agli urti, a norma DIN 18032-3 e UNI 9554, 259x118x15 cm

Outdoor scoreboard displaying game time, team scores (0-99) and period (0-9). Each 45cm digit is composed of 264 SMD LEDs. The time of day is automatically displayed when the console is turned off or disconnected. Impact resistant. Complies with DIN 18032-3 and UNI 9554 standards 259x118x15 cm

art. 8464 Come art. 8460 ma con nome squadra programmabile (8 caratteri per squadra alti 25 cm) 333x99x15 cm

like 8460 but with the team name programmable (8 characters per team, 25 cm high) 333x99x15 cm

art. 8465 Come art. 8463 ma con nome squadra programmabile (8 caratteri per squadra alti 25 cm) 333x158x15 cm

like 8465 but with the team name programmable (8 characters per team, 25 cm high) 333x158x15 cm

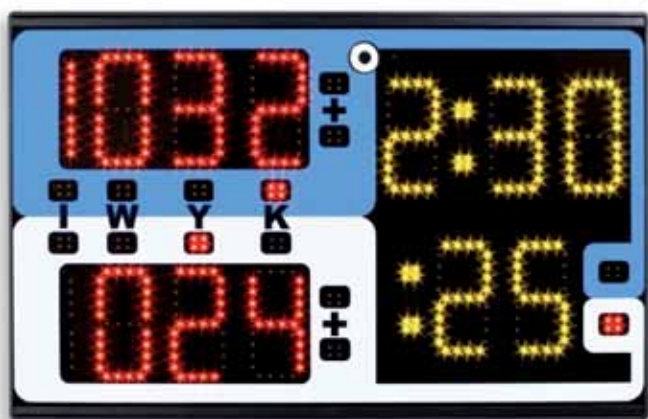

art. 1369 Tabellone elettronico multisport per judo, pugilato, spinning, taekwondo ecc. / dim. cm 55x35x9,5

Portable scoreboards for judo contests, boxing, taekwondo, spinning etc.

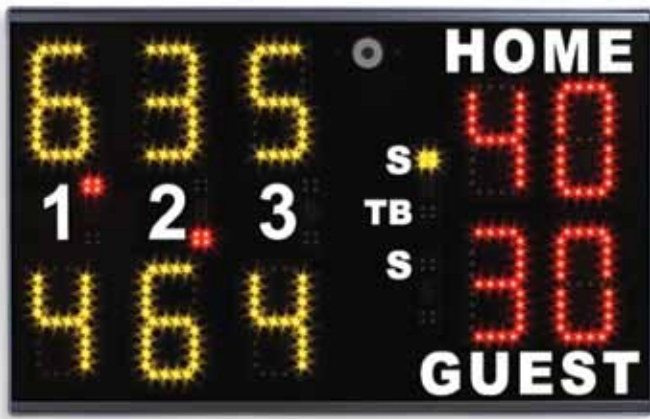

art. 7585 Tabellone elettronico per tennis (3 set) cm 55x35x9,5
Portable tabletop scoreboard for tennis



art. 8446 Cronometro per la visualizzazione del tempo per sport anche con radiocomando
Chronometer for sport, numeral height 20 cm



art. 8451 Tabellone elettronico per attività sportive e di palestra boxe, spinning, aerobica
Timer for boxing, spinning, aerobica



art. 8452 Versione da tavolo
Desktop version



art. 8481 Tabellone indicatore di 24 secondi con la visualizzazione del timer (con cifre da 0 a 99 alte 30 cm), del tempo di gioco (con cifre alte 14 cm) e della luce rossa (ø 15 cm) 70,5x60x11,5 cm
24 second shot clock (digits from 0 to 99, 30 cm high), game time (digits 14 cm high) and red light (ø 15 cm) 70,5x60x11,5 cm



art. 8480 Tabellone indicatore di 24 secondi con la visualizzazione del timer (con cifre da 0 a 99 alte 20 cm) e della luce rossa (ø 8 cm) 41x29x8,5 cm
24 second shot clock (digits from 0 to 99, 20 cm high) and red light (ø 8 cm) 41x29x8,5 cm



art. 8486 Console principale di pilotaggio, completa di valigetta
Main control console



art. 8443 Kit 24 secondi cifre alt. cm 20 con console di comando 29,2x30,4x4,4cm

24 second shot clock panels, digit 20 cm high with control console 29,2x30,4x4,4 cm



art. 8483 Tabellone indicatore di 24 secondi con la visualizzazione su 4 lati del timer (con cifre da 0 a 99 alte 30 cm), del tempo di gioco (con cifre alte 14 cm) e della luce rossa (ø 15 cm) 72x60x72 cm Omologato FIBA

24 second shot clock (digits from 0 to 99, 30 cm high), game time (digits 14 cm high) and red light (ø 15 cm), 4 sided display 72x60x72 cm FIBA approved



art. 8438 Indicatore luminoso di possesso palla alternato conf. norme F.I.B.A.

Ball possession electronic marker



art. 6443 Segnalatore luminoso elettronico per cambio giocatori 4 cifre contemporaneamente

Electronic scoreboard with four digits, simultaneously



Timer clock

art. 8455 Cronometro da esterno

Outdoor timer

TRIBUNE

spectator seating systems



VIVISPORT



art. 8502 Palazzetto dello sport di Trieste: 2200 posti a sedere su tribuna telescopica ad apertura manuale, predisposta alla motorizzazione. N. 12 file con posti a sedere su scocca autoportante rialzata. Sui lati corti per garantire la fascia di rispetto del basket sono state installate tribune con posti a sedere su panchetta rialzata

Hall of Sports of Trieste (Italy). 2.200 seating places on telescopic grandstand, manual opening type pre-set for motorization. Grandstand having 12 rows with seating places on individual load self-supporting shells. On the short sides, respecting the court area, were install grandstands with seating places



DOHA – QATAR -AL ARABI SPORT CLUB – Art. 8502 - Tribuna telescopica motorizzata con scale di smistamento superiori. Accessi all'area di gioco sottotribuna. Posti a sedere su poltroncina con schienale ribaltabile e corrimano in plexiresit.

DOHA – QATAR -AL ARABI SPORT CLUB – Motor operated telescopic platform with understructure vomitory, tilting backrest seat and custom made plexresit handrails.



art. 8509 Seduta per schienale, ignifuga classe 1. Jesolo
Back seating anti-fire class 1, UV rays. Jesolo



art. 8502 Palazzo dello Sport di CIVIDALE DEL FRIULI - UD (Italy): 1200 posti a sedere su tribuna telescopica predisposta alla motorizzazione. Tribune a sette file con piano di seduta rialzato.
Hall of Sports of CIVIDALE DEL FRIULI – UD (Italy). 1.200 seating places on telescopic grandstand, manual opening type pre-set for motorization. Grandstand having 7 rows with seating places on individual load self-supporting shells



Modulo tribuna da 2,5 metri a 3 file in acciaio, ribaltabile, con n. 15 seggiolini

Compact stand use 2,5 mt with 3 steps, in steel, foldable, with 15 seats

art. 8571 Modello fisso in acciaio zincato

Fix in hot galvanized steel

art. 8575 Kit ruote di trasformazione da fissa a trasportabile per moduli tribuna art. 8570 - 8571

Kit of wheels to transform from fix to mobile for the compact stands item 8570 - 8571





Modulo tribuna da 2 metri a 3 file in acciaio verniciato, ribaltabile e trasportabile con ruote

Compact stand use 2 mt with 3 steps in painted steel, foldable and mobile on wheels

art. 8562 Seduta composta da doghe in alluminio anodizzato con inserto in pvc colore blu

Seat with beams in anodized aluminium with film in PVC in blue colour



Modulo tribuna da 2 metri a 3 file per esterno, in acciaio zincato a caldo, ribaltabile e trasportabile con ruote

Compact stand use 2 mt with 3 steps in galvanized steel, foldable and mobile on wheels

art. 8563 Seduta composta da doghe in alluminio anodizzato

Seat with beams in anodized aluminium



art. 8516 Seduta con schienale ignifuga classe 1, 420x400x320 mm

Fireproof polypropylene seat, with backrest 420x400x320 mm

art. 8517 Struttura in acciaio con seduta ribaltabile e schienale

Tip up frame with fireproof polypropylene seat, with backrest

art. 8507 Seduta senza schienale ignifuga classe 1, 400x350x102 mm

Fireproof polypropylene seat, without backrest 400x350x102 mm

art. 8509 Seduta con schienale ignifuga classe 1, 440x450x350 mm

Fireproof polypropylene seat, with backrest 440x450x350 mm



art. 8505 Pedana modulare
Modular platform



art. 8521 Transenna impilabile realizzata in tubo acciaio zincato
Ø 40 mm cm 225x110h. con fascia rifrangente
Crush barrier with reflective strip cm 225x110h



art. 8520 Transenna impilabile realizzata in tubo acciaio zincato Ø 40 mm cm 225x110 h
Crush barrier cm 225x110h.





art. 8500 Tribuna fissa zincata per esterno
Fixed grandstand hot galvanized



SPOGLIATOI INFERMERIA

dressing rooms - massage





art. 9104 Armadio spogliatoio metallico a 2 posti sovrapposti
180x70x35 cm
*Painted sheet steel wardrobe, 2 stratified lockers. 4 doors
180x70x35 cm*

art. 9101 Armadio spogliatoio metallico a 2 posti
180x70x35 cm
Painted sheet steel locker. 2 doors 180x70x35 cm

**Panca spogliatoio in acciaio con telaio in tubo quadro,
doghe in legno verniciato al naturale**

art. 9005 Panca spogliatoio solo seduta 1 mt
Locker room bench simple Length 1 mt

art. 9006 Panca spogliatoio solo seduta 2 mt
Locker room bench simple Length 2 mt

art. 9011 Panca spogliatoio con seduta, schienale, appendiabiti
e pianoborse 1 mt
*Locker room bench, with backrest, clothes rail and ledge
bags support length 2 mt*



art. 9102 Armadio spogliatoio metallico a 3 posti
180x102x35 cm
Painted sheet steel locker. 3 doors 180x102x35 cm



art. 9105 Armadio spogliatoio metallico a 3 posti sovrapposti
180x102x35 cm
*Painted sheet steel wardrobe, 3 stratified lockers. 6 doors
180x102x35 cm*



Disponibili con ante colorate
Available with colored doors

art. 1055 Casellario portavolanti a 50 vani
Port record values - 50 compartments
82x95x20 cm



art. 1036 Armadio corazzato di sicurezza con 2 ante e 4 ripiani
100x50x135 cm
Security lockers, 4 shelves,
2 shutters



art. 9116 Armadio in acciaio con ante in inox ad 1 posto
180x41,5x50 cm
Steel wardrobe with stainless steel door, 1 locker,
180x41,5x50 cm



art. 9117 Armadio in acciaio con ante in inox a 2 posti
180x80x50 cm
Steel wardrobe with stainless steel door, 2 lockers
180x80x50 cm



art. 9106 Armadio in rete verniciato con maniglioni e ruote 153x76x176 h cm
Casellario a 10 vani 180x70x35 cm
Painted sheet steel locker with 10 small compartments 180x70x35 cm



art. 9118 Armadio spogliatoio in laminato a 3 posti sovrapposti con serratura
Stratified laminated locker, 3 compartments



art. 1048 Armadio in rete verniciato con maniglioni e ruote 153x76x176 h cm
Equipments and balls rack, with 2 folding doors and 4 wheels 153x76x176 h cm



art. 1042 Armadio porta attrezzi con 4 ripiani 200x100x45 cm
Equipment locker, steel, 4 shelves, 2 shutters 200x100x45 cm



Spogliatoio su misura Cagliari Calcio





art. 8626 Panca spogliatoio con seduta, schienale, appendiabiti e pianoborse 1 mt

Locker room bench, with backrest, clothes rail and ledge bags support Lenght 1 mt

art. 8627 Panca spogliatoio con seduta, schienale, appendiabiti e pianoborse 2 mt

Locker room bench, with backrest, clothes rail and ledge bags support Lenght 2 mt

art. 9092 Pedana poggiapiedi in alluminio 1 mt

Aluminium footrest with rubber feet 1 mt

art. 9093 Pedana poggiapiedi in alluminio 2 mt

Aluminium footrest with rubber feet 2 mt



art. 8606 Panca spogliatoio con seduta, schienale, appendiabiti e pianoborse 1 mt

Locker room bench, with backrest, clothes rail and bags support Lenght 1 mt

art. 8607 Panca spogliatoio con seduta, schienale, appendiabiti e pianoborse 2 mt

Locker room bench, with backrest, clothes rail and bags support Lenght 2 mt

Panca spogliatoio in alluminio con telaio in tubo quadro, doghe in alluminio anodizzato



art. 8600 Panca spogliatoio solo seduta 1 mt
Locker room bench simple Length 1 mt



art. 8601 Panca spogliatoio solo seduta 2 mt
Locker room bench simple Length 2 mt



art. 8602 Panca spogliatoio con seduta e schienale 1 mt
Locker room bench, with backrest Length 1 mt



art. 8603 Panca spogliatoio con seduta e schienale 2 mt
Locker room bench, with backrest Length 2 mt



art. 8622 Panca spogliatoio con seduta e schienale 1 mt
Locker room bench, with backrest Length 1 mt



art. 8623 Panca spogliatoio con seduta e schienale 2 mt
Locker room bench, with backrest Length 2 mt



art. 8624
Panca spogliatoio con seduta, schienale e appendiabiti 1 mt
Locker room bench, with backrest, clothes rail Length 1 mt



art. 8625
Panca spogliatoio con seduta, schienale e appendiabiti 2 mt
Locker room bench, with backrest, clothes rail Length 2 mt



Gruccia Appendiabiti In PP di serie
Clothes Rail In Security Pp series

art. 9027 Panca spogliatoio con seduta, schienale, appendiabiti e pianoborse 2 mt

Locker room bench, with backrest, clothes rail and ledge bags support Lenght 2 mt

art. 9091 Pedana poggiapiedi a listoni di legno 2 mt

Wooden footrest with rubber feet 2 mt



Gruccia Appendiabiti in acciaio su richiesta
Also available with Clothes Rail double steel coat hooks request.

art. 9012 Panca spogliatoio con seduta, schienale, appendiabiti e pianoborse 2 mt

Locker room bench, with backrest, clothes rail and ledge bags support Lenght 2 mt

art. 9091 Pedana poggiapiedi a listoni di legno 2 mt

Wooden footrest with rubber feet 2 mt



Panche in alluminio, telaio in tubo rotondo \varnothing 40 mm antinfortunistico con piedini regolabili.

Panca spogliatoio in alluminio con telaio in tubo rotondo, doghe in alluminio anodizzato con inserto in pvc colore blu

aluminium locker benches, tubular aluminium tube \varnothing 40 mm Safe Locker room bench in aluminium with tubular aluminium tubing, beams in anodized aluminium with beams film in PVC in blue colour

art. 8726 Panca spogliatoio con seduta, schienale, appendiabiti e pianoborse 1 mt

Locker room bench, with backrest, clothes rail and bags support Length 1 mt



art. 8721 Panca spogliatoio solo seduta 2 mt

Locker room bench simple Length 2 mt



Panche in acciaio, da assemblare
Panca spogliatoio in acciaio, doghe in legno verniciato al naturale

Bench in steel, to assemble Locker room bench in steel, beams natural wood painted

art. 8800 Panca spogliatoio solo seduta
1 mt

Locker room bench simple 1 mt

art. 8802 Kit cappelliera con
appendiabiti e piano
poggiaborse per panca 8800,
1 mt

Kit with backrest, clothes rail and bags support for item 8800 1 mt





Panca spogliatoio in alluminio con montanti in tubo rotondo e traversi in tubo rettangolare, doghe in legno verniciato al naturale, piedini antiscivolo regolabili

Locker room bench in aluminium with tubular steel tubing and rectangular steel tubing, beams in natural wood painted

art. 8766 Panca spogliatoio con seduta, schienale, appendiabiti e pianoborse 1 mt

Locker room bench with backrest, clothes rail and ledge bags support 1 mt





art. 9190 Panche per sale di attesa, in acciaio, 2 posti

Waiting rooms chair, made in steel, 2 seats

art. 9191 Panche per sale di attesa, in acciaio, 3 posti

Waiting rooms chair, made in steel, 3 seats



art. 6811 Coppia carrelli per il trasporto di una porta calcetto/pallamano

Pair of trolley for the transport of one footsal/handball goal

art. 9192 Panche per sale di attesa, in acciaio, 4 posti

Waiting rooms chair, made in steel, 4 seats

art. 9193 Panche per sale di attesa, in acciaio, 5 posti

Waiting rooms chair, made in steel, 5 seats



art. 9140 Appendiabiti a parete modello "Riccio", a 2 posti, con telaio in metallo grigio

Wall clothes hangers model "Riccio", 2 hangers

art. 9141 Appendiabiti a parete modello "Riccio", a 3 posti, con telaio in metallo grigio

Wall clothes hangers model "Riccio", 3 hangers

art. 9142 Appendiabiti a parete modello "Riccio", a 4 posti, con telaio in metallo grigio

Wall clothes hangers model "Riccio", 4 hangers

art. 9143 Appendiabiti a parete modello "Riccio", a 5 posti, con telaio in metallo grigio

Wall clothes hangers model "Riccio", 5 hangers





art. 9120 Tavolo per spogliatoio piano sagomato in gomma
100x60 cm
Locker room table 100x60 cm

art. 4313 Sedia plastica imbottita
Stuffed chair in steel / plastic

art. 9161 Cestino gettacarta in pvc
Plastic trashcan



art. 9019 Panca spogliatoio solo seduta, modello a mensola
1 mt
Locker room bench, shelf model Length 1 mt



art. 9200 Lettino imbottito testiera inclinabile verniciato
Medical examination couch, reclining headrest

art. 9202 Scendiletto a 2 gradini
Steel bedside step ladder



art. 9184 Lettino in legno a 3 segmenti, gambe regolabili
in altezza
*Wooden medical examination couch, three sections,
height adjustable legs*



art. 9171 Lettino imbottito a piano fisso per massaggi verniciato
Medical examination couch, fixed plan

art. 9203 Supporto porta lenzuolino in acciaio
Paper roll holder



art. 9180 Lettino per massaggi in legno smontabile, chiudibile a valigia

Foldable and transportable examination and massage couch



art. 9181 Lettino visita medica in legno, test.inclinabile, imbottito mod. Ponto

Wooden medical examination couch, reclining headrest



art. 9096 Graticcio in plastica per doccia componibile 50x50 cm

*Modular plastic shower plastic.
Dim. 50x50 cm*



art. 9095 Graticcio in plastica per doccia 60x60 cm

Plastic footrest. Dim. 60x60 cm

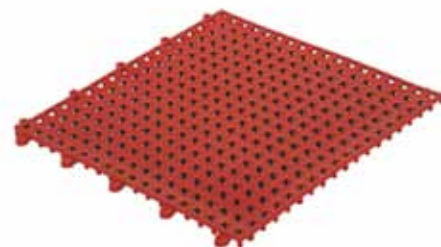

art. 9098 Pavimentazione modulare multiuso set 9 pezzi

*Modular plastic footrest.
Dim. 333x333 mm set 9 pcs.*



art. 9151 Asciugamani, asciugacapelli automatico con temporizzatore 3 minuti

Automatic hand hairdryer 3 minutes

art. 9152 Asciugacapelli automatico con tubo flessibile

Automatic hairdryer with flexible pipe



art. 9157 Specchio con cornice in plastica ø 50 cm

Wall mirror with plastic frame ø 50 cm



art. 9249 Bilancia pesapersona con statimetro modello "Elegant" mod. Wunder

Scales for persons with height measuring, Wunder model



art. 9235 Portantina chiudibile in acciaio cromato, pieghevole in 2 pezzi dim. 203x50xh14 cm

Foldable stretcher dim. 192x50xh30 cm



art. 9200 Lettino imbottito testiera inclinabile verniciato

Medical examination couch, reclining headrest

art. 9220 Attaccapanni su colonna cromato con portaombrelli

Clothes stand in painted steel and plastic

art. 9210 Scrivania in legno con cassetiera a 3 cassetti

Writing desk, with chest of two drawers

art. 9201 Armadio portamedicinali a vetri dim. 60x40xh160 cm

Infirmery locker, 1 door dim. 60x40xh160 cm



art. 9230 Paravento a 3 ante

Three shutter screen with foldable painted steel



art. 9290 Parallela per deambulazione piano in bilaminato

Deambulation parallel bars, bilaminated footboard

art. 9291 Parallela per deambulazione chiudibile

Folding deambulation parallel bars

art. 9292 Telaio con divisori

Footboard divided in section

art. 9293 Piani inclinati per percorso concavo e convesso

Two section footboard, concave or convex

art. 9294 Piano di camminamento a lisca di pesce

Fish-bone footboard

art. 9295 Sacchetto calpestio riempito di sabbia

Motor training sand bag

art. 9296 Sacchetto calpestio riempito di granuli in pvc

Motor training bag with PVC grains



art. 9251 Rianimatore manuale Asibox (bombola esclusa acquistabile solo in farmacia)
Life support system

art. 9252 Rianimatore manuale Apollo bombola ricaricabile
Life support system, rechargeable bottle



art. 9254 Defibrillatore
Defibrillator



art. 9242 Borsa di medicazione completa medico/massaggiatore
First aid medical bag doctor/masseur



art. 9241 Cassetta di medicazione in abs, portatile o appl. a muro, completa di accessori
Portable first aid kit box



art. 9243 Cassetta di medicazione in abs, compl. cps 517
First aid kit box

PROTEZIONI DI SICUREZZA

safety protections



VIVISPORT



art. 9912 Protezione copritermo
Radiator stuffed protection



art. 9900 Protezione per colonna a sezione tonda
Column protection, round section



Protezioni di qualsiasi misura e spessore a richiesta
Safety protection, thickness and measures to application



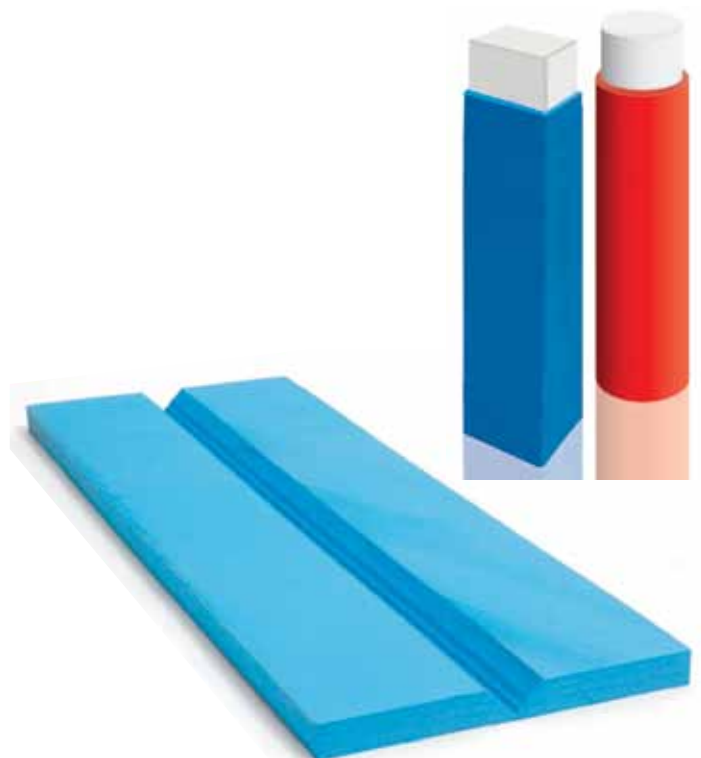

art. 9902 Protezione murali a pannello
Indoor protections for wall

art. 9903 Protezione paraspigoli
Corner protections



art. 9901 Protezione per colonna a sezione quadra
Column protection, square section

art. 8512 Tenda divisoria elettrica
Separate extends



ALTRI SPORT

others sports



VIVISPORT



art. 8101 Mensola per sacco girevole accostabile a parete
Wall punching platform for pivoting punching bag

art. 8116 Sacco fascia cuoio con catena e moschettone 50 Kg
Leather band punching bag with chain and spring 50 Kg



art. 8101 Mensola per sacco girevole accostabile a parete
Wall punching platform for pivoting punching bag



art. 8114 Sacco fascia cuoio con catena e moschettone 30 Kg
Leather band punching bag with chain and spring 30 Kg



art. 8150 Sacco boxe con pedana riempibile alt. 180/210 cm
ø 40 cm - h. sacco 110 cm
Boxing bag with boxing stand, can be filled, height 180/210 cm ø 40 cm



art. 1540 Pallone leggero palla pugno in pvc - FIPAP 65 gr
Light ball smash in PVC - FIPAP 65 gr



art. 1530 Tamburello indoor scuola ø 28 cm
School indoor tambourine ø 28 cm

art. 1531 Palla depressurizzata non omologata da allenamento
Training ball, depressurized



art. 9962 Calciobalilla con gettoniera, con aste passanti.
Modello MUNDIAL
Football table for indoors with slot for coins



art. 9961 Calciobalilla senza gettoniera, con aste passanti.
Modello FUN
Football table for indoors



art. 9930 Calciobalilla senza gettoniera modello F-200 con aste uscenti

Indoor freeplay football table model F-200



art. 9932 Calciobalilla senza gettoniera modello G-100 con aste uscenti

Indoor freeplay football table model G-100



art. 9934 Calciobalilla senza gettoniera modello G-500 con aste uscenti

Indoor freeplay football table model G-500



art. 9936 Calciobalilla senza gettoniera modello G-2000 con aste uscenti

Indoor freeplay football table model G-2000



art. 9940 Calciobalilla senza gettoniera modello G-5000 on aste uscenti

Indoor freeplay football table model G-5000



art. 9944 Calciobalilla senza gettoniera modello G-500W con aste uscenti

Outdoor freeplay football table model G-500W



art. 9937 Calciobalilla senza gettoniera modello G-2000 con aste rientranti

Indoor freeplay football table model G-2000 with telescopic safety bars

art. 9938 Calciobalilla senza gettoniera modello FOLDY con aste uscenti e gambe pieghevoli

Indoor freeplay football table model FOLDY with foldable legs

art. 9939 Calciobalilla senza gettoniera modello FOLDY con aste rientranti e gambe pieghevoli

Indoor freeplay football table model FOLDY with foldable legs and telescopic safety bars



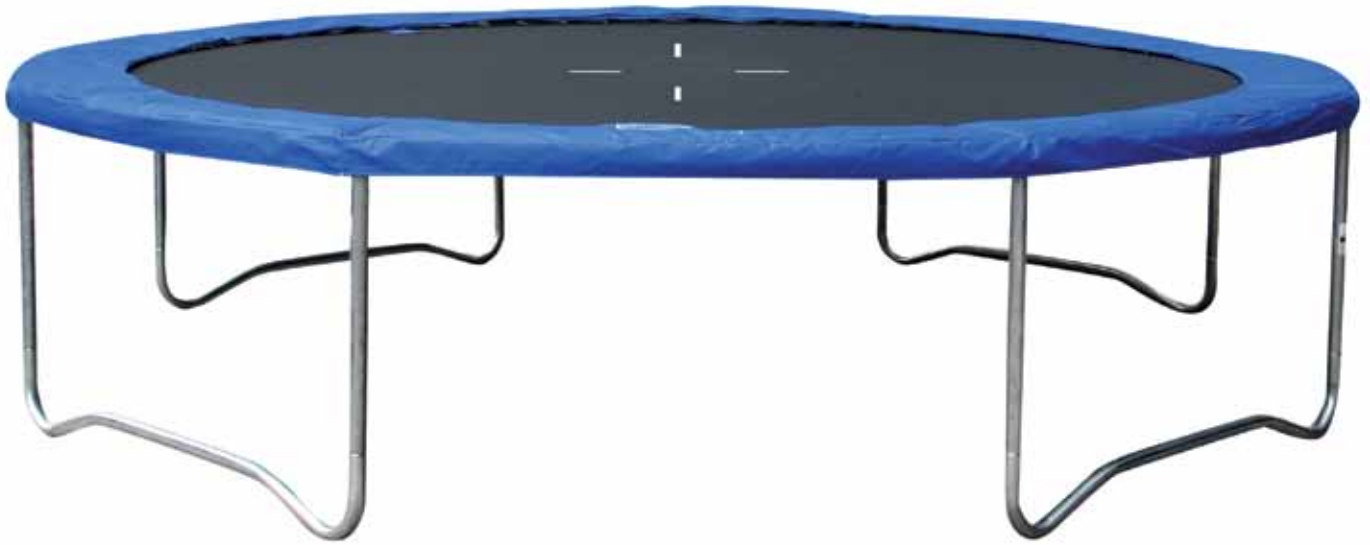

art. 1755 Trampolino da esterno ø 183 cm
Outdoor tramp ø 183 cm

art. 1757 Trampolino da esterno ø 423 cm
Outdoor tramp ø 423 cm

art. 1756 Trampolino da esterno ø 305 cm
Outdoor tramp ø 305 cm



art. 1760 Rete di protezione per art. 1755
Safety enclosure for item 1755

art. 1762 Rete di protezione per art. 1757
Safety enclosure for item 1757

art. 1761 Rete di protezione per art. 1756
Safety enclosure for item 1756



art. 9750 Mini arena multisport polivalente
Mini arena multisport



art. 9751 Mini arena
Street soccer







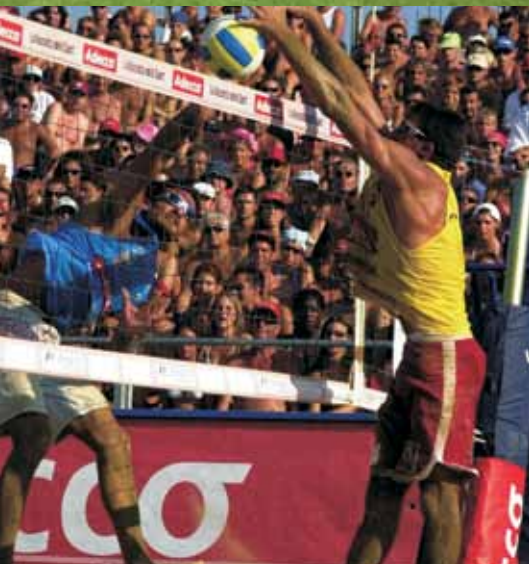

VIVISPORT

codice / code	pagina / page	codice / code	pagina / page	codice / code	pagina / page
1002	151	1463	157	20041	167
1005	146	1464	157	20042	167
1020	157	1465	157	20043	167
1021	157	1500	157 - 158	2009	167
1022	157	1504	158	2010	167
1030	154	1505	158	2011	167
1031	154	1509	158	2013	168
1037	163	1510	155	2014	168
1042	163 - 206	1511	155	2015	168
1043	163	1512	155	2017	168
1044	163	1513	155	2022	172
1045	81	1515	152	2023	172
1047	80	1516	154	2024	173
1048	163 - 206	1517	155	2025	173
1052	163	1518	155	2026	173
1055	205	1519	155	2027	173
1060	157	1530	227	2032	167
1061	157	1531	227	2033	167
1062	157	1540	227	2034	167
1063	157	1550	149	2035	167
1064	157	1551	149	2038	44 - 172
1065	157	1552	148	2039	44
1081	157	1553	148	2040	42 - 171
1083	157	1562	149	2041	43 - 171
1085	157	1564	173	2042	42 - 172
1086	157	1571	162	2043	171
1088	158	1572	162	2046	168
1100	157	1573	162	2048	171
1101	157	1574	162	2050	173
1102	157	1576	162	2051	173
1104	157	1579	150	2052	45
1105	158	1580	150	2053	168
1154	146	1583	150	2056	166
1157	147	1585	150	2062	167
1160	161	1595	162	2063	167
1164	147	1602	149	2064	167
1168	147	1604	149	2065	167
1170	151	1610	153	2066	167
1201	160	1611	153	2071	168
1203	160	1681	153	2072	168
1251	160	1682	153	2096	168
1257	160	1683	153	2099	166
1282	161	1684	153	2100	166
1289	161	1685	153	2101	166
1290	160	1691	152	2120	166
1350	159	1696	152	2121	176
1351	159	1699	152	2122	176
1352	159	1700	162	2124	176
1353	159	1701	162	2125	176
1361	161	1702	162	2129	176
1364	159	1708	156	2132	176
1369	161 - 190	1709	37 - 156	2133	176
1377	49 - 159	1752	36 - 156 - 183	2136	176
1379	180	1755	229	2140	176
1380	158	1756	229	2143	174
1382	159	1757	229	2152	173
1385	157	1760	229	2154	173
1385	157	1761	229	2156	174
1386	159	1762	229	2157	175
1387	157	1800	154	2158	175
1390	151	1801	154	2160	175
1420	151	1802	154	2161	175
1428	151	1803	154	2163	175
1429	151	2001	166	2164	175
1461	157	2002	166	2170	173
1462	157	2004	167	2172	174

codice / code	pagina / page	codice / code	pagina / page	codice / code	pagina / page
2174	174	3270	143	4267	107
2178	174	3273	139	4268	112
2181	174	3285	139	4270	101
2201	43 - 172	3288	140	4271	106
2300	169	3290	141	4276	113
2301	169	3305	139	4277	106
2302	169	3307	139	4279	101
2303	169	3410	140	4282	105
2304	170	3421	140	4285	104
2305	170	3525	141	4290	102
2306	170	3532	141	4300	119
2307	170	3602	141	4302	119
2308	170	3606	140 - 142	4304	119
2309	170	3610	141	4305	119
2310	169	3613	141	4307	117
2311	169	3617	141	4308	80 - 118
2315	170	3626	142	4309	117
2320	169	3630	142	4309	117
2321	169	3701	142	4313	119 - 215
2322	169	3733	142	4316	119
2323	170	3734	142	4318	81 - 119
2324	170	3800	141	4325	117
2330	40	4001	113	4382	119
2331	40	4002	109	4385	77 - 118
2332	40	4003	115	4400	107 - 108
3001	138 - 143	4004	115	5002	68
3001	143	4005	115	5003	68
3002	138 - 143	4007	115	5005	68
3002	143	4008	115	5009	67
3005	138	4009	113	5010	68
3008	138	4010	115	5013	67
3009	138	4013	116	5020	69
3010	138	4014	116	5021	70
3012	138	4015	115	5022	70
3013	137	4016	115	5025	69
3014	137	4050	114	5026	69
3015	46	4051	114	5029	69
3016	46	4052	114	5050	74 - 75
3018	47	4054	114	5051	75
3019	47	4055	114	5054	73
3020	47	4056	114	5057	73
3021	47	4082	116	5060	74
3023	46	4090	118	5069	78
3024	46	4091	77 - 118 - 125	5070	75
3031	137	4116	113	5071	75
3032	137	4117	113	5080	75
3034	136	4118	118	5081	76
3036	136	4119	112	5082	76
3039	137	4124	113	5083	41
3041	137	4125	112	5084	41 - 77
3046	46	4200	108	5101	76
3047	46	4201	108	5106	77
3049	143	4202	107	5109	77
3050	137	4223	108	5201	79
3069	143	4224	109	5202	79 - 80
3070	143	4225	110	5205	79
3071	143	4226	110	5207	79
3073	143	4227	113	5210	80
3078	143	4229	111	5212	80
3079	143	4230	111	5300	70
3081	143	4231	112	5304	70
3082	136	4232	112	5400	80
3085	143	4248	107	5401	80
3089	143	4252	107	5403	72
3210	139	4263	112	5404	71 - 86 - 96
3213	139	4265	106	5407	71

codice / code	pagina / page	codice / code	pagina / page	codice / code	pagina / page
5408	72	6234	27	6503	48
5409	71	6237	28	6504	48
5412	69	6240	32 - 62	6505	48
5413	78	6241	32 - 62	6506	48
5414	81 - 88	6242	62	6507	48
5417	68	6243	62	6508	48
5427	81	6254	28	6509	48
5428	78 - 88	6285	32	6510	50
5429	97	6286	20 - 29 - 32 - 33	6516	40
5430	79	6289	32	6800	58
5431	78 - 89	6291	30 - 63	680011	61
5434	81	6293	31	6802	59
5435	81	6318	39	6804	61
5437	81	6330	20 - 32	6805	61 - 130
5438	43 - 77 - 143	6340	20	6807	24 - 61
5439	71	6401	49 - 129	6809	25 - 61
5500	88 - 96	6403	49 - 129	6811	60 - 131 - 163 - 214
5510	86 - 97	6404	40 - 124	6812	58 - 130
5511	88 - 94	6405	50	6813	58 - 130
5512	86	6406	80 - 94	6815	60
5513	87	6407	80 - 94	6816	60
5515	87	6408	51	6820	59
5516	87 - 96	6409	51	6821	59 - 61
5520	89	6410	51	6900	93
5525	68 - 88 - 97	6411	51	6905	93
5526	85 - 97	6415	51	6908	94
5527	69	6420	38	7001	130
5530	88	6422	35	7010	131
5531	88	6423	38	7011	131
5540	89 - 97	6431	34	7015	131
5543	88	6432	35	7500	123
5545	85 - 97	6439	35	7501	123
5900	21	6440	45	7503	123
590010	24 - 59	6441	48	7505	123
5901	22	6442	45	7506	123
5905	23	6443	51 - 192	7507	122
5907	23 - 34	6444	51	7521	122
5910	23	6451	39	7540	124
5911	24	6452	39	7541	125
6007	36	6454	50	7542	125
6008	36	6456	47	7544	125
6019	25 - 61	6460	50	7548	124
6026	35	6464	50	7549	125
6027	25	6465	38	7562	124
6028	25	6470	51	7569	86 - 124
6030	36	6474	51	7585	124 - 191
6032	36	6475	38	7700	132
6036	21	6476	38	7710	132
6038	24	6478	35	7715	132
6040	22 - 24	6479	38	7716	132
6041	21	6480	39	7901	133
6043	34	6481	39	7905	133
6044	21 - 22 - 61 - 131	6483	40	7908	133
6047	22 - 39 - 61 - 131	6484	40	7925	133
6100	23	6485	40	8001	129
6105	37	6486	37	8002	129
6107	22 - 37	6487	37	8010	129
6108	21 - 23 - 37	6488	38	8101	226
6120	23 - 24	6490	33	8101	226
6125	25	6492	35	8114	226
6200	63	6494	50	8116	226
6212	20 - 32	6495	35	8142	214
6214	29	6496	50	8150	226
62203	33	6498	48	8390	187
6224	27	6501	48	8404	186
6233	129	6502	48	8438	119 - 192

codice / code	pagina / page	codice / code	pagina / page	codice / code	pagina / page
8441	187	9019	215	9316	183
8442	187	9027	210	9322	172
8443	192	9091	210	9323	44
8444	188	9092	208	9324	44
8445	188	9093	208	9325	44
8446	191	9095	216	9330	183
8449	187	9096	216	9331	183
8451	191	9098	216	9333	179
8452	191	9101	204	9390	183
8453	188	9102	204	9401	180
8455	192	9104	204	9402	180
8460	189	9105	204	9403	180
8461	189	9106	206	9404	180
8462	189	9116	205	9405	180
8463	190	9117	205	9418	45
8464	190	9118	206	9424	45
8465	190	9120	215	9429	45
8470	188	9140	214	9433	181
8471	188	9141	214	9434	181
8472	188	9143	214	9435	181
8473	187	9151	217	9438	181
8474	187	9152	217	9446	181
8475	186	9157	217	9452	183
8480	191	9161	215	9453	183
8481	191	9171	215	9518	180
8483	192	9178	41	9520	180
8486	191	9180	216	9521	180
8490	189	9181	216	9522	180
8492	189	9184	215	9551	181
8499	189	9190	214	9555	180
8500	201	9191	214	9556	181
8502	192 - 193	9192	214	9593	157
8505	199	9193	214	9606	179
8507	198	9200	215 - 218	9607	179
8509	195 - 198	9201	218	9710	178
8512	224	9202	215	9711	178
8516	198	9203	215	9712	178
8517	198	9210	218	9713	178
8520	199	9220	218	9714	178
8521	199	9230	218	9715	178
8562	64 - 197	9235	217	9716	178
8563	198	9241	219	9750	230
8570	56	9242	219	9751	231
8571	196	9243	219	9900	222
8575	56 - 196	9249	217	9901	224
8600	209	9251	219	9902	116 - 223
8601	209	9252	219	9903	223
8602	209	9254	219	9912	222
8603	209	9290	218	9930	228
8606	208	9291	218	9932	228
8607	208	9292	218	9934	228
8622	209	9293	218	9936	228
8623	209	9294	218	9937	228
8624	209	9295	218	9938	228
8625	209	9296	218	9939	228
8626	208	9301	171	9940	228
8627	208	9303	171	9944	228
8721	211	9305	171	9961	227
8726	211	9308	171	9962	227
8766	213	9310	183	9972	125
8800	212	9311	183		
8802	212	9312	42 - 183		
9005	204	9312	183		
9006	204	9313	183		
9011	204	9314	183		
9012	210	9315	183		



www.vivisport.it



VIVISPORT

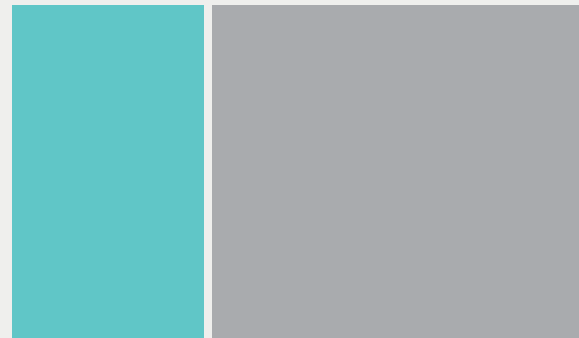

VIVISPORT srl

Via Mazzini, 56/m
31026 Sarmede (TV) Italy
Tel. +39 0438 582316
Tel. +39 0438 582318
Fax +39 0438 582042
E-mail: info@vivisport.it

www.vivisport.it

 Vivisport SRL

